

***BOXFORD lathe
accessories
and additional
equipment***

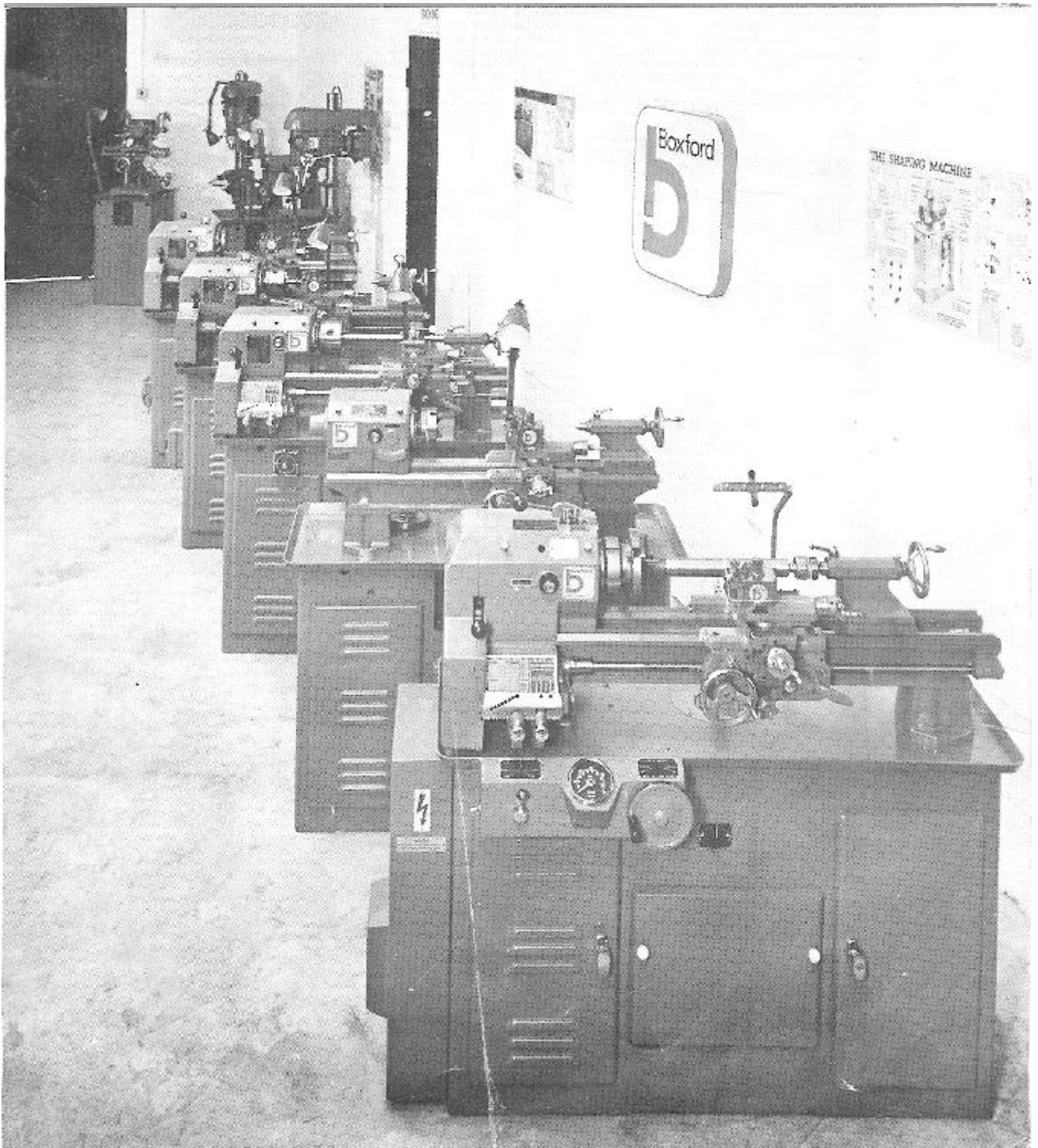

Bed Turret, Cut off Slide and Cross Slides

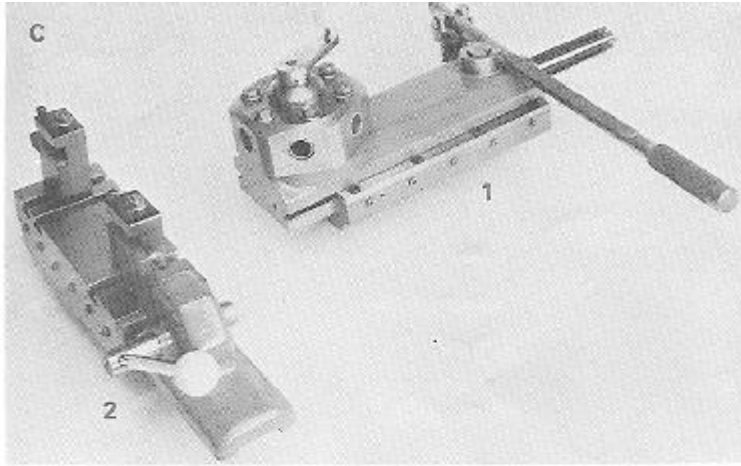

C

- 1 **HANDLEVER BED TURRET** with 6 station turret head for 3/4ins dia (or metric equivalent) shank tools, automatic index on return stroke. Separate adjustable feed screws for each turret position to control length of cut. Maximum stroke of turret 100mm (4in). If ordered with lathe the turret is accurately fitted and bored ready to receive tools, but if ordered separately the customer must finish bore tooling holes in position on own machine.
- 2 **HANDLEVER CUT-OFF SLIDE** complete with adjustable height toolposts, mounts direct on the lathe bed in place of saddle. Cross traverse 100mm (4in) with adjustable stop for each toolpost.

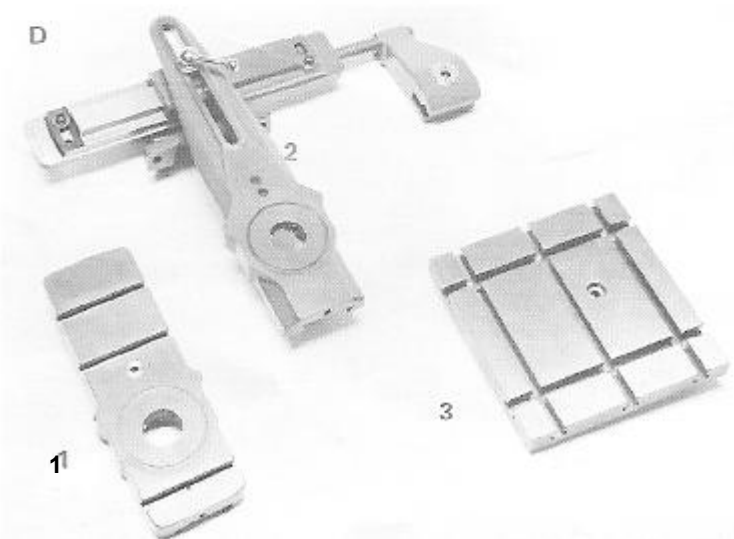

D

- 1 **T-SLOTTED CROSS SLIDE** similar to standard cross slide but equipped with three 12.7mm (1/2in) wide T-slots for holding work pieces or rear toolposts. An adjustable rear toolpost M4 is available for this slide.
- 2 **TAPER TURNING ATTACHMENT** has a nominal taper turning length of 180mm (7in) and a minimum angular setting of 20° inclusive, tapers can be set in millimetres per centimetre (inches per foot on imperial machines) in degrees or as a ratio. The special cross slide which replaces the standard one is supplied with a nut for conventional turning. For taper turning the nut is removed and cross movement is controlled from the slide at the rear. It is recommended that this attachment is fitted at our works.
- 3 **BORING TABLE** replaces the cross slide on the saddle of the lathe and has 150mm (6in) cross movement. The 200 X 200mm (8 X 8in) table is provided with five T-slots for clamping workpieces. The table can be locked in position on the saddle.

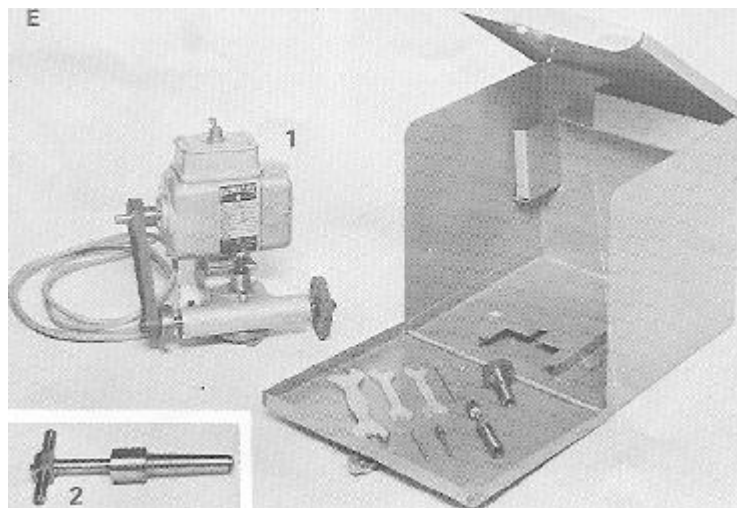

E

- 1 **TOOLPOST GRINDER** is made to fit on the tool slide of the lathe and is adjustable for centre height. Supplied in a strong sheet-metal box complete with two external and three internal wheels, wheel extension, collet attachment, spanners and dressing stick. Motor 0.1kW (1/8hp) Approx. spindle speeds 10,000 and 21,000rpm.
- 2 **DIAMOND DRESSING ATTACHMENT** for toolpost grinder, consists of a 0.5 carat diamond mounted in adjustable holder for fixing in tailstock of lathe.

Cabinet Base Rear Splash Guard, Swarf Tray and Coolant Equipment

A

1 STANDARD CABINET FOR BENCH LATHES, available in two different sizes to suit machines with 560 and 710mm (22 or 28in) between centres. The cabinet is fabricated from heavy gauge mild steel plate welded throughout, painted standard blue-grey finish.

Two lock-up tool cupboards complete with wooden shelves are provided, the heavy gauge tray is fitted with coolant collecting sump as standard.

An electrical compartment with hinged access panel, punched for electrical equipment is formed in the front centre section. (Illustration shows reversing/isolator switch fitted as extra equipment.) When cabinet is ordered without electrics a blanking plate is fitted.

The rear spacer between headstock and tailstock legs is made in the form of a coolant tank which can be supplied with or receive electric coolant pump equipment at a later date. Four 14mm (9/16in) dia holes are provided for fastening the cabinet to the floor and holes for lifting immediately beneath the tray.

The cabinet tray can be supplied drilled ready to suit the machine providing the model and serial number of the machine is quoted.

3 REAR SPLASH GUARD made from mild steel sheet suitably stiffened and cranked ready for fixing to STANDARD cabinets or swarf tray 4. Painted standard blue-grey finish.

4 SWARF TRAY for use with machine mounted on customers own bench. Two lengths are available to suit 560 or 710mm (22 or 28in) between centre machines. Swarf trays complete with coolant sump can be supplied if required.

Painted standard blue-grey finish.

B

1 COOLANT EQUIPMENT comprising electric pump, adjustable coolant fittings, delivery and return pipes, complete with switch.

2 COMPOSITE TANK/PUMP with switch unit available for bench machines or machines mounted on cabinets prior to standard cabinet shown at A1. (Not illustrated.)

A



1

A

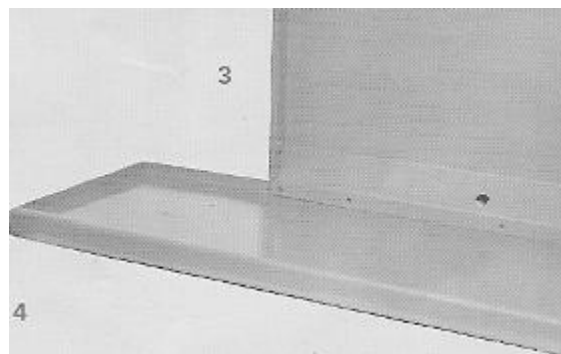

/B

1

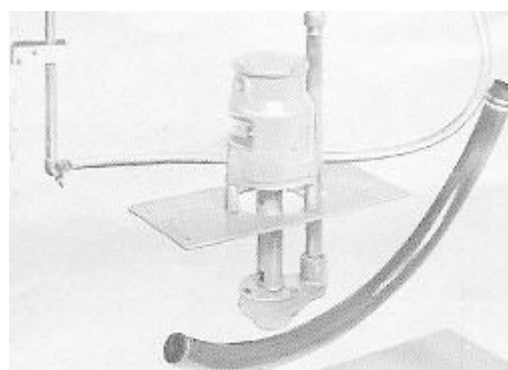

Milling and Dividing Attachments, Dust Cover Hand Rest and Chip Guards

F

MILLING ATTACHMENT comprising:

- 1 Column
- 2 Universal Base
- 3 Table
- 4 Vice

The milling attachment column fits on the Universal base which replaces the lathe compound rest slide and uses the cross slide engraving for angular settings. The vertical slide on the column is graduated and either the table or vice can be secured to the slide. Both can be swivelled through 360° and both spigots are offset to give maximum adaptability. The movement of the vertical slide is 125mm (5in) and the dial reads in .02mm (or .001in). The spigots of the table and vice permit them to be mounted directly on the cross slide in lieu of compound rest.

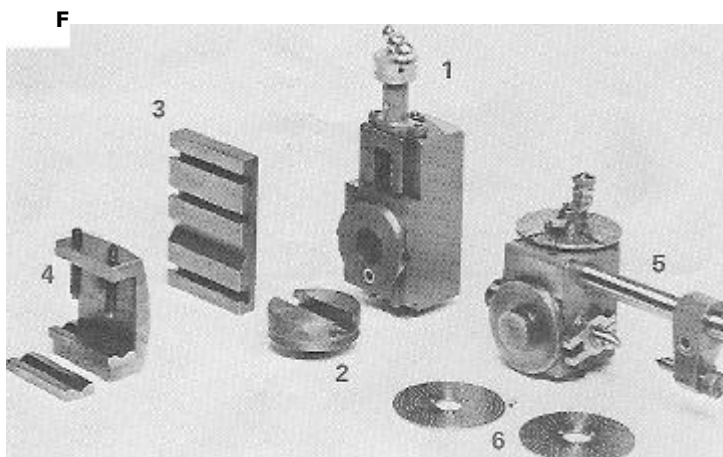

DIVIDING ATTACHMENT comprising:

- 1 Column
- 5 Worm Box
- 6 Three Index Plates

The dividing head column mounts on the tool slide of the lathe and the vertical slide receives the worm box which encloses a 40:1 reduction unit. With the three standard index plates provided, a wide range of divisions can be obtained. The spindle is double ended, one end having a No 1 Morse taper for holding work mandrels between centres supported by the overarm bracket and the other threaded to take a 80mm (3in) chuck J1. Max. dia. of work between centres is 80mm (3in) and max. length between centres is 90mm (3.1/2in). Travel of vertical slide is 125mm (5in) and spindle end sizes are (i) No 1 Morse taper bore (ii) 1.1/8in dia. X 11tpi whit form.

NB The columns of both dividing head and milling attachment are identical, so that only one column is necessary for both.

- 7 **MILLING ARBOR** 25mm (1 in) dia 150mm (6in) long with No 3 Morse taper for mounting directly into the headstock spindle. The shank is tapped and a draw bolt provided with standard spacing collars.



G

HAND REST, for wood turning and thread chasing, comprising:

- 1 Base which fixes in lathe cross slide
- 2 305mm (12in) Tee Rest
- 3 100mm (4in) Tee Rest

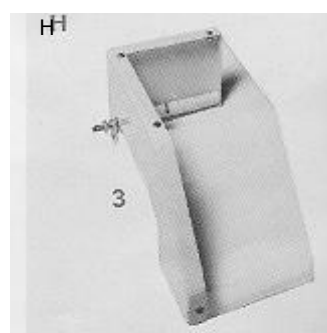
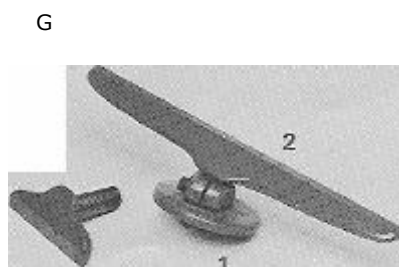

H

- 1 **PERSPEX HINGED CHIP GUARD** mounts on right rear of wing saddle.

- 2 **REAR PERSPEX SHIELD**, as illustrated, can be supplied as an extra.

- 3 **PERSPEX CHUCK GUARD** mounts on headstock. This guard can be fitted in conjunction with an electrical safety interlock

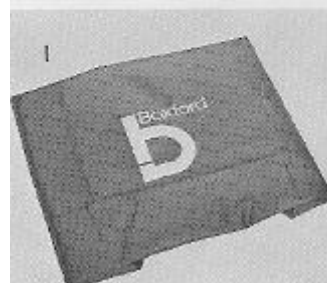

PLASTIC DUST COVER available in three sizes for lathes, bench and underneath drive models.

Please quote Serial Number, Bed Length, Model and Electrical details where applicable when ordering.

Chucks, Collet, Disc and Ring Chucks, Multisize Collet Chucks, and Collets

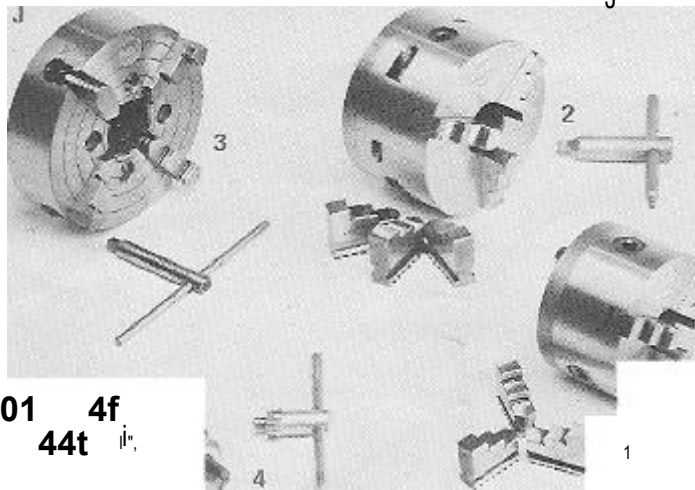

01 4f
44t in.

CHUCKS

- 1 80mm (3in) 3 jaw self centering chuck and backplate for dividing head F5.
 - 1 100mm (4in) 3 jaw self centering, with backplate.
 - 1 125mm (5in) 3 jaw self centering, with back plate.
 - 2 100mm (4in) 3 jaw self centering, griptrue with backplate.
 - 2 125mm (5in) 3 jaw self centering, griptrue with backplate.
 - 3 100mm (4in) 4 jaw independent with backplate.
 - 3 150mm (6in) 4 jaw independent with backplate.
 - 4 12.7mm (1/2in) capacity drill chuck No 2 Morse taper.
- NB* All chucks are supplied with an operating key.
- 3 jaw self centering chucks have two sets of hard jaws, one for internal and one for external gripping, 4 jaw independent chucks have one set of hard reversible jaws. Soft jaws can be supplied as extra equipment.

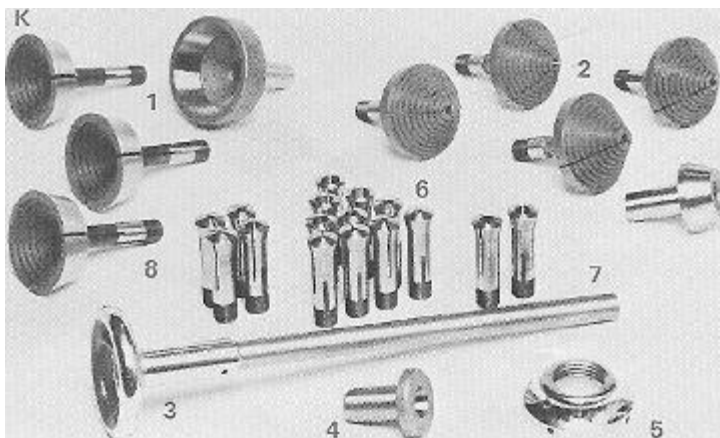

K

- 1 **DISC CHUCKS** (External) with closing adaptor (set of 4) capacity 1/2in to 2.1/2in, 1/16in increments (3 only illustrated) alternative range 3/4in to 3in as special order. (Metric sizes to order.)
 - 2 **RING CHUCKS** (internal) with closing adaptor (set of 4) capacity 1/2in to 2.11/16in, 1/16in increments. (Metric sizes to order.)
- NB* Disc and ring chucks require a drawbar 3 (as supplied with draw-in collet attachment) to operate closing adaptor.

DRAW-IN COLLET ATTACHMENT complete with:

- 3 **Draw Bar**
- 4 **Collet Adaptor** for 12.5mm (1/2in) capacity spring collets,
- 5 **Nose Cap**
- 6 **COLLETS** for above Round 12.5mm (1/2in) dia max.
- 7 **COLLETS** for above HEXAGON 11mm (7/16in) A/F max.
- 8 **COLLETS** for above SQUARE 9.5mm (3/8in) max.

L

- 1 **LC10 MULTISIZE LEVER** operated dead length collet chuck with backplate and special mounting bracket and front cover. LC15/LOO (Vari-speed machines).
- 2 **KC10 MULTISIZE KEY** operated collet chuck with backplate KC15/LOO (Varispeed machines).

MULTISIZE COLLETS ROUND 25.4mm (tin) max.

MULTISIZE COLLETS HEXAGON 19mm (3/4in) max.

- 3 **MULTISIZE COLLETS** set of 8 round 1.6 to 25.4mm (1/16 to 1 in).

Tool posts Tool Holders for American and English type Tool posts

M

TOOLPOSTS

1 AMERICAN TYPE SINGLE TOOLPOST.
For tool shank 22 X 9.5mm (7/8 X 3/8in).

2 ENGLISH TYPE SINGLE 'CLOG HEEL' TOOLPOST. For tool shank 16 X 9.5mm (5/8 X 3/8in).

3 FOURWAY TOOLPOST 76mm (3in) square indexes in eight positions. For tool shank 16 X 9.5mm (5/8 X 3/8in).

4 ADJUSTABLE TYPE REAR TOOLPOST.
For 9.5 X 9.5mm (3/8 X 3/8in) square tool.

5 BOXFORD QC (Quick Change) Toolpost with necessary wrenches. Parting Tool

M

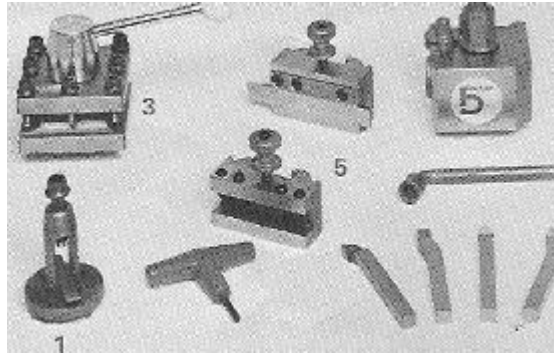

N

TOOL HOLDERS FOR AMERICAN TYPE SINGLE TOOLPOST with Tool Shank 22 X 9.5mm (7/8 X 3/8in).

- 1 **STRAIGHT RH or LH** turning tool holders with HSS 6mm (1/4in) bit.
- 2 **STRAIGHT RH or LH** parting off tool holders with HSS blade.
- 3 **EXTERNAL THREAD CUTTING TOOL HOLDER** with Whitworth form cutter. Additional cutters for above to order.
- 4 **KNURLING TOOL HOLDER** with two cast steel medium, spiral, knurls. Extra knurls for above 16 X 8mm (5/8in dia X 5/16in wide) to order.
- 5 **KNURLING TOOL HOLDER** self adjusting type (identical to 05).
- 6 **DOUBLE ENDED ONE PIECE BORING BAR** with HSS bits.
- 7 **BORING TOOL HOLDER** with two internal HSS boring bars and bit.

N

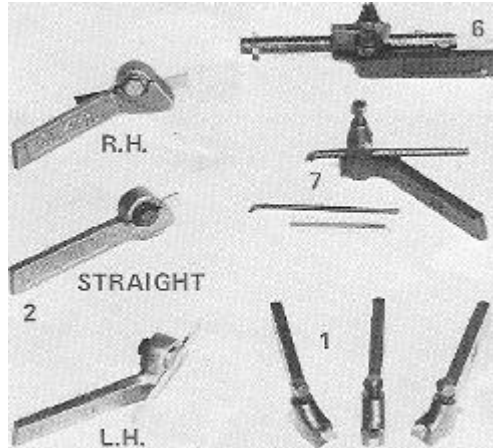

R.H. STRAIGHT L.H.

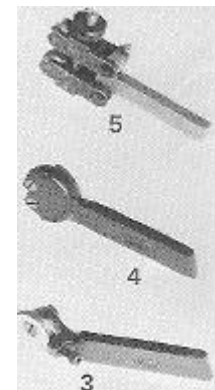

0

TOOL HOLDERS FOR 4-WAY or CLOG-HEEL TYPE TOOLPOST with Tool Shank 16 X 9.5mm (5/8 X 3/8in).

- 1 **STRAIGHT, RH or LH** turning tool holder with HSS 6mm (1/4in) bit.
- 2 **STRAIGHT PARTING OFF TOOL HOLDER** with HSS blade.
- 3 **EXTERNAL THREAD CUTTING TOOL HOLDER** with whit form cutter. Additional cutters for above to order.
- 4 **KNURLING TOOL HOLDER** with two cast steel medium, spiral knurls. Extra knurls for above 16 X 3mm (5/8 in dia X 5/16in wide) to order.
- 5 **KNURLING TOOL HOLDER** self adjusting type with two cast steel, fine spiral knurls. Extra knurls for above 19 X 9.5mm (3/4in dia X 3/8in wide) to order.
- 6 **DOUBLE ENDED ONE PIECE BORING BAR** with HSS bits.
- 7 **SET OF TWELVE HSS** shaped turning tools in stand, shank 9.5 X 9.5mm (3/8 X 3/8in).
- 8 **SET OF EIGHT TUNGSTEN CARBIDE** tipped shaped turning tools shank 9.5 X 9.5mm (3/8 X 3/8in).

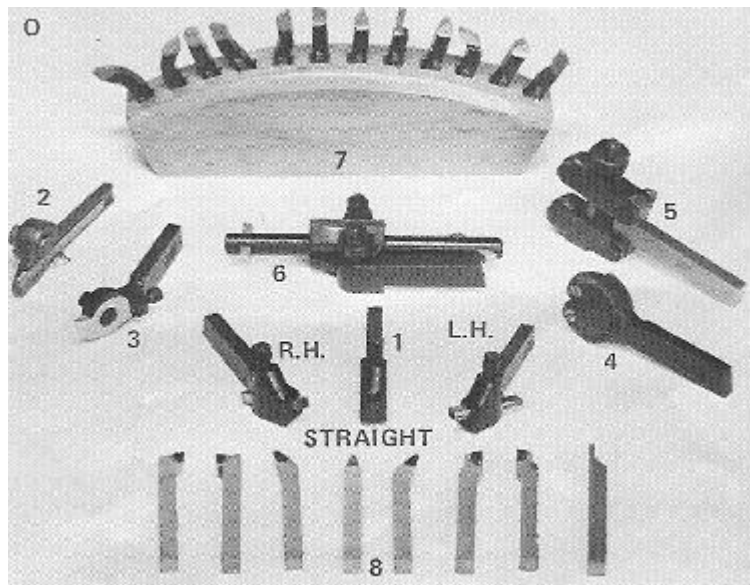

Centres, Work Supports, Driving Plates and Accessories Carriage and Saddle Stops,

P

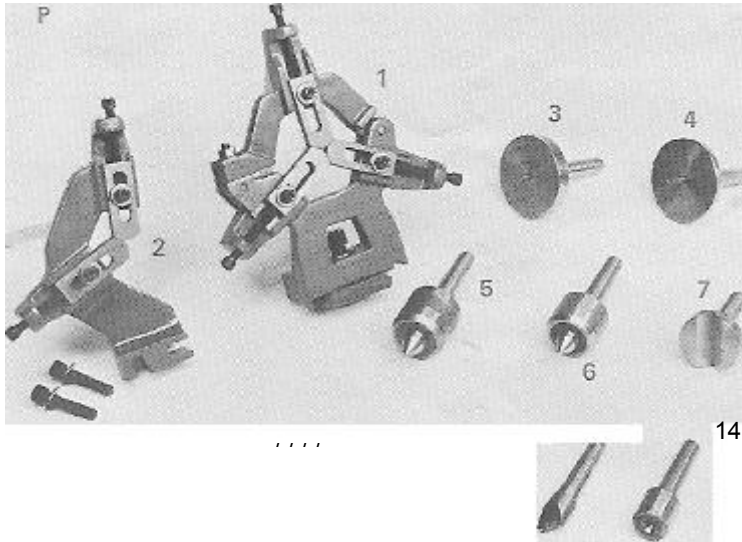

CENTRES AND WORK SUPPORTS

- 1 **FIXED STEADY** clamps on inside ways of lathe bed, used for supporting long shafts, boring, etc. The three jaws are adjustable, the top half of the fixed steady is hinged to facilitate insertion and removal of work. Capacity 6 to 63mm dia (1/4 to 2.1/2in dia).
- 2 **TRAVELLING STEADY** is attached to the saddle and travels with it, used to support long slender shafts between centres. Can be attached or removed quickly. Capacity 6 to 38mm dia (1/4 to 1.1/2in dia).
- 3 **DRILL PAD** 75mm (3in) dia face No 2 Morse taper shank.
- 4 **SCREW CENTRE** No 2 Morse taper shank.
- 5 **ROTATING CENTRE** No 2 Morse taper
- 7 **V-CENTRE PAD** No 2 Morse taper shank
- 8 **60° CENTRE hard.** No 2 Morse taper.
- 9 **60° CENTRE, soft.** No 2 Morse taper.
- 10 **HALF CENTRE hard**
- 11 **CUP CENTRE** No 2 Morse taper
- 12 **SQUARE CENTRE** Morse taper
- 13 **SPUR CENTRE**
- 14 **FEMALE CENTRE hard**

Q

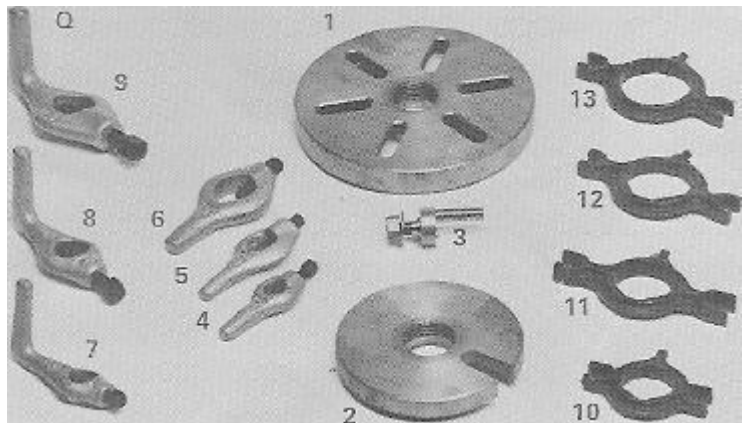

DRIVING PLATES AND ACCESSORIES

- 1 **FACEPLATE** 203mm (8in) nominal, 187mm (7.3/8in) actual diameter.
- 2 **CATCH or DRIVING PLATE** 130mm (5.1/8in) diameter.
- 3 **DRIVING STUD** for above. For use with straight lathe dogs or 'Acme' lathe carriers.
- 4 **STRAIGHT DOG** for 12.7mm (1/2in) dia.
- 5 **STRAIGHT DOG** for 19mm (3/4in) dia.
- 6 **STRAIGHT DOG** for 25mm (1 in) dia.
- 7 **BENT TAIL DOG** for 12.7mm (1/2in) dia.
- 8 **BENT TAIL DOG** for 19mm (3/4in) dia.
- 9 **BENT TAIL DOG** for 25mm (1 in) dia.
- 10 **'ACME' CARRIER** for 30mm dia.
- 11 **'ACME' CARRIER** for 35mm dia.
- 12 **'ACME' CARRIER** for 40mm dia.
- 13 **'ACME' CARRIER** for 50mm dia.

R

CARRIAGE AND SADDLE STOPS

- 1 **MICROMETER CARRIAGE STOP.** For micrometer adjustment of saddle movement, nominal max. adjustment 9.5mm (3/8in).
- 2 **PLAIN CARRIAGE STOP**
- 3 **FOUR POSITION CARRIAGE STOP**
- 4 **SADDLE LIMIT SWITCH** for lathes fitted with push button starter with no-volt protection. The adjustable striker bar is mounted on a bracket fixed to the rear of the saddle, and operates the micro switch secured at the rear of the bed, when the saddle is fed towards the headstock. The angled mounting plate for the micro switch also acts as a positive mechanical stop after the micro switch has cut off power.

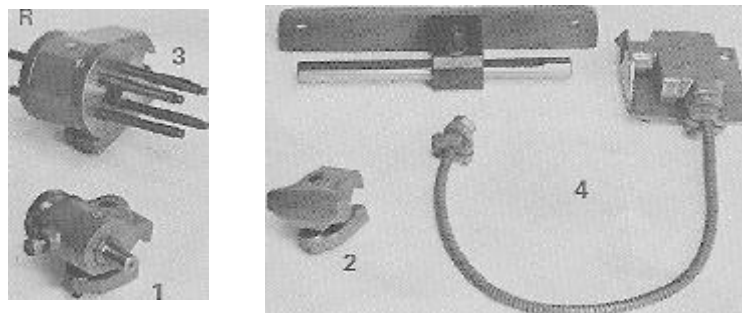

Screw Cutting Accessories, Change and Conversion Gears

S SCREW CUTTING ACCESSORIES

S

- 1 THREAD DIAL INDICATOR, English lead-screw (illustrated). Complete with adaptor block for metric machines (not illustrated).
- 2 THREAD CUTTING STOP
- 3 THREADING TOOL SETTING GAUGE
- 4 TAILSTOCK DIE HOLDER for 20.6mm (13/16in) dia dies No 2 Morse taper.
- 5 TAILSTOCK DIE HOLDER for 25.4mm (1 in) dia dies No 2 Morse taper.
- 6 TAILSTOCK TAP HOLDER with 12.7mm (1/2in) dia socket. 12.7mm (1/2in) dia bushes to suit taps can be supplied as extras on request.

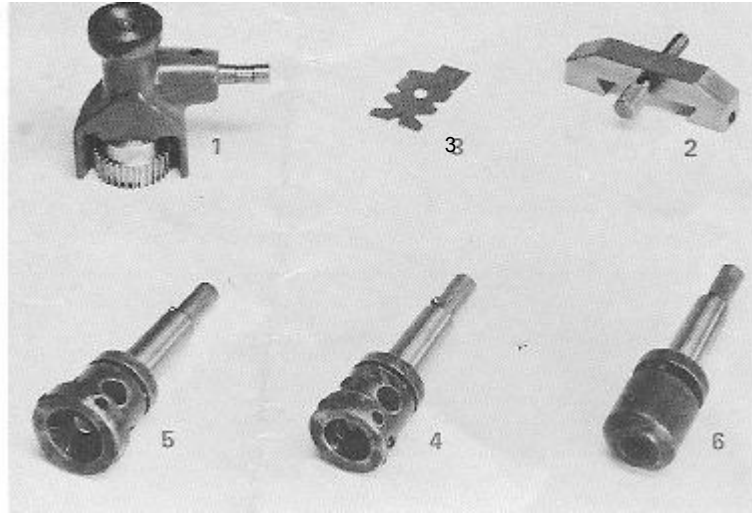

T CHANGE GEARS AND CONVERSION GEARS

- 1 METRIC CONVERSION GEARS for lathes with English leadscrew Model A and AUD (9 gears).
- 2 METRIC CONVERSION GEARS for lathes with English leadscrew Model B, C, BUD, CUD (4 gears).
- 3 BA CONVERSION GEARS for lathes with English leadscrew Model A, AUD (10 gears).
- 4 BA CONVERSION GEARS for lathes with English leadscrew Model B, C, BUD, CUD (10 gears).
- 5 ENGLISH CONVERSION GEARS for lathes with metric leadscrew Model A and AUD (7 gears).
- 6 ENGLISH CONVERSION GEARS for lathes with metric leadscrew Model B, C, BUD, CUD (11 gears).
- 7 METRIC CONVERSION GEARS for Varispeed lathes with English leadscrew Model VSL/LOO (10 gears).
- 8 BA CONVERSION GEARS for Vari-speed lathes with English leadscrew Model VSL/LOO (10 gears).
- 9 ENGLISH CONVERSION GEARS for Vari-speed lathes with Metric leadscrew Model VSL/LOO (8 gears).

T

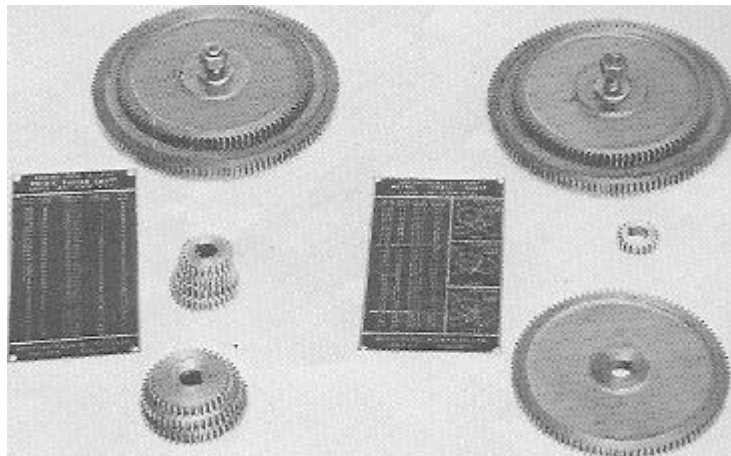

SPECIAL CHANGE GEARS for non standard pitches or for extra fine feeds, available on request.

Please quote Serial Number, Bed Length, Model and Electrical details where applicable when

Boxford Machine Tools Ltd., Wheatley,
Halifax, Yorkshire, England HX3 5AF.
Tel. 0422 58311/3. Telex 517410.
Grams. Boxford Halifax.