

PRATT & WHITNEY

12" MODEL "C" LATHE

INSTRUCTION BOOK



PRATT & WHITNEY

DIVISION NILES-BEMENT-POND COMPANY

WEST HARTFORD 1, CONNECTICUT

Branch Offices — BIRMINGHAM BOSTON CHICAGO CINCINNATI CLEVELAND DALLAS (The Stanco Co.) DETROIT
HOUSTON (The Stanco Co.) LOS ANGELES NEW YORK PHILADELPHIA PITTSBURGH ROCHESTER SAN FRANCISCO ST. LOUIS

12" MODEL "C" LATHE
OPERATOR'S INSTRUCTION BOOK

PRATT & WHITNEY COMPANY
Incorporated

West Hartford 1, Connecticut U.S.A.

INDEX

Important Notice	1694-R-4
Installation	1694-R-5
Cleaning	1694-R-5
Leveling	1694-R-5
Lubrication	1694-R-6
Cleaning	1694-R-6
Types of Drives	1694-R-7
Motor Drive	1694-R-7
Main Line or Jackshaft Drive	1694-R-7
Headstock	1694-R-7-10 inclusive
Main Driving Clutch	1694-R-7-8
Spindle and Cam-Lock Spindle Nose	1694-R-8-9
Headstock Gear Train	1694-R-10
Leadscrew and Feed Rod Gear Box	1694-R-10-11
Ratio Gear Box	1694-R-10
Operation of Leadscrew and Feed Rod Gear Box	1694-R-10-11
Tool Carriage	1694-R-11-15 inclusive
Hand Operation	1694-R-11-12
Cross Slide Positive Stop	1694-R-12
Compound Slide Rest	1694-R-12
Adjustment of Carriage Gibs	1694-R-13
Carriage Clamp	1694-R-13
Forward and Reverse Clutch	1694-R-13
Stop Collars	1694-R-14
Power Operating Using the Feed Rod	1694-R-14
Thread Cutting	1694-R-14
Thread Cutting Dial	1694-R-15
Metric Equipment	1694-R-15
Tailstock	1694-R-15-16
Operation of the Lathe	1694-R-16-17
Storage	1694-R-17-18
Additional Equipment	1694-R-18-26 inclusive
Expansion Arbors and Bushings	1694-R-18
Step Chucks	1694-R-18
Follow Rest	1694-R-18
Collet Mechanism	1694-R-18
Micrometer Carriage Stop	1694-R-19
Taper Attachment	1694-R-19-21 inclusive
Turning 45° Bevels	1694-R-20
Turning Bevels Greater than 45°	1694-R-20-21
Multiple Indexing Face Plate	1694-R-21
Carriage Spacing Attachment	1694-R-21-22
Pump and Piping Equipment	1694-R-22
Speed Reducer	1694-R-22-24 inclusive
Relieving Attachment	1694-R-24-26 inclusive
Oversize Steady Rest	1694-R-26
Other Additional Equipment	1694-R-26
Specifications	1694-R-26-27

INDEX TO ILLUSTRATIONS AND CHARTS

Figure A - Front and Rear Views	1694-R-29
Figure B - Headstock and Headstock Gearing	1694-R-31
Figure C - Cam-Lock Spindle Nose	1694-R-33
Figure D - Apron and Carriage	1694-R-35
Figure E - Operating Levers	1694-R-37
Figure F - Regular Equipment	1694-R-39
Figure G - Additional Equipment	1694-R-41
Figure H - Additional Equipment	1694-R-43
Figure J - Floor Plan	1694-R-44
Figure Ja- Proper Method of Lifting the Lathe	1694-R-44A
Figure K - Lubrication Chart	1694-R-45
Figure L - Speed and Feed Diagram	1694-R-46
Figure M - Multiple Thread Indexing	1694-R-47
Figure N - Thread Chasing Dial (English)	1694-R-48
Figure Nm- Thread Chasing Dial (Metric)	1694-R-49
Figure O - Change Gears for Special Threads (English)	1694-R-50
Figure Om- Change Gears for Special Threads (Metric)	1694-R-51
Figure Pm- Metric Thread Chart	1694-R-52
Figure Q - Index to Diametrical Pitches	1694-R-53
Figure R - Leads and Threads with Speed Reducer	1694-R-54
Figure Sm- English to Metric Transposition	1694-R-55
Figure Tm- Metric to English Transposition	1694-R-56

IMPORTANT NOTICE

In order to use this book correctly, it should be noticed that all reference numbers throughout the text are related to a particular illustration. For instance the number B-3 refers to the number which appears on Figure B.

When sending to the factory for information on this machine, please refer to this book, giving the specific page numbers in full as they appear in the upper corners of the pages which refer to the question in hand.

All such requests should bear the serial number of the machine as it appears on the brass plate attached to the machine and stamped on the bed.

Requests for additional information on machines will be welcomed and will be given our full attention at any time.

The life, service and satisfaction derived from any machine tool depends in a large measure on the care and attention given it. The operator should be familiar with the contents of this instruction book before attempting to operate the lathe.

INSTALLATION

The lathe is shipped in one crate. When it is necessary to take the machine through a window, or under some similar conditions where an elevator is not available, do not uncrate it until it is on the floor on which it is to be located.

It should be placed in position, using the Floor Plan, Figure J, at the back of this book, to obtain the correct clearances. The foundation should be solid and free from vibration. Do not grout the feet in concrete. See Figure Ja showing the proper method of lifting the lathe.

Examine the lathe carefully and report to Pratt & Whitney at once any damage that may have occurred in transit.

Cleaning

The lathe as shipped is covered with a heavy grease to protect it against rust. This grease should be carefully cleaned off with kerosene and clean rags. Do not smear the grease into oil pockets or grooves. To clean the leadscrew, place the "Thread-Feed" lever B-7 in its neutral position and turn the leadscrew A-5 by hand, making sure the thread is thoroughly clean before engaging the leadscrew nut.

Do not get grease or oil on the motor drive V-belts as it will shorten their life.

Leveling

The lathe should be carefully leveled before it is bolted to the floor. The lathe is equipped with screws for leveling purposes, and checking the level and making adjustments from time to time is a simple matter. Steel plates measuring $\frac{1}{4}$ " minimum thickness by 6" square should be used under all leveling screws.

The level of the bed in the lengthwise or longitudinal direction is not important.

In order to maintain the accuracy built into the machine the bed must not be twisted or strained. These conditions can readily be checked by leveling across the ways at both ends of the bed, and at the middle when the machine has a center leg.

An accurate level should be used for setting up and checking. The Pratt & Whitney Precision Level is an excellent instrument for this purpose.

1. Before leveling, make sure that the leveling screws are contacting the floor - not the cabinet legs.
2. Back off leveling screws 3 and 4 (Fig. J) so that they do not support the machine.
3. Place the level across the flats of the bed on a pair of size blocks or accurate parallels. Use a square with the precision level to be certain the instrument is at right-angle to length of bed.
4. Level the machine bed at both ends (and in the middle if machine has a center leg), using screws 1, 2, 5, and 6 (Fig. J.)
5. After the machine is accurately leveled, turn down leveling screws 3 and 4 (Fig. J) to equal finger tight only.

Leveling (Con't)

After the machine is leveled it should be bolted to the floor, but the machine must not be tightened down to such an extent that the initial leveling is upset. Check the level of the machine once more after it has been bolted to the floor. Never grout the machine legs or leveling screws to the floor.

In one or two weeks after the machine is set up the leveling should be carefully checked and also periodically thereafter. If you have difficulty boring a true hole or turning a cylindrical stud in a chuck without a tailstock support, recheck the leveling before writing us about it.

LUBRICATION

Before operating the machine lubricate it, as some of the oil may have been removed by the kerosene used in cleaning it.

The lubrication chart, Figure K, at the back of this book, gives complete information of the points to lubricate and the grade of oil to use.

The headstock, the speed control gear box for the leadscrew and the feed rod, and the tool carriage are all equipped with oil reservoirs and pumps for automatically distributing the oil to the moving parts when the lathe is running. Keep the reservoirs filled to the levels indicated on the oil gages A-9, A-11 and A-21.

An oil filter A-20 is located at the rear of the headstock. Give the projecting cross handle a few turns once a week to scrape off any foreign matter that may have accumulated.

Before pouring oil into oil cup A-13 on the leadscrew and feed rod gear box, move rocker lever A-1 to its extreme right-hand position.

To lubricate the rocker gear multiple spline shaft located in the leadscrew and feed rod gear box B-4, reach in with an oil can through the large opening in the front of this gear box.

The oiling of machine tools is often neglected when high production is being maintained, or at best is only attended to occasionally. Properly regulated shops usually require machines to be gone over each morning and noon when they are in continuous service, and time is allowed once a week for thorough cleaning and adjustment. Proper attention to these details will greatly increase the life of the lathe.

CLEANING

This lathe has been painted National Machine Tool Builders' gray, using "Peroxylin" paint. Soda water and cutting compounds will not hurt the finish.

It is well known that many machine tools are worn out sooner than necessary simply because dirt has been allowed to settle in the moving parts and has cut the wearing surfaces. A clean machine will last longer, look better and give better service. A high grade lathe of this sort deserves good treatment. Keep it clean.

TYPES OF DRIVESMotor Drive (Fig.A)

A 3 hp 1800 rpm constant speed, ball bearing motor either a-c or d-c, is recommended for this lathe.

The motor is located in the left-hand pedestal A-10 and is mounted on a swinging platform with bolts for adjusting the tension of the V-belts.

Belts may be changed by removing the cover at rear, near top of guard, and the end cover from the left-hand pedestal. Belts are assembled thru the top opening and placed on the driven sheave and then over the motor sheave. Belt tension may be checked by removing cabinet leg cover only.

The motor starter is mounted within the belt guard closure at the left-hand end of the machine.

The electrical circuit is completely wired and placed in conduits. All the electrician has to do is connect the wires to the motor starter. The motor should drive the headstock pulley A-23 at the rate of 1000 rpm in the direction indicated by the arrow on the pulley guard.

The push button switch A-12 for the motor is conveniently located on the front of the gear box.

Do not run the V-belts too tight.

Tighten the check nut on the motor platform before operating the lathe.

HEADSTOCKMain Driving Clutch (Fig. A)

A double end multiple disc clutch A-22 is mounted on the primary drive shaft. One end is used for driving the gear train to the spindle and the other end as a brake.

Either of the two levers, A-2 and A-8, operate the clutch and brake. Movement of lever A-2 to the right or an upward movement

Main Driving Clutch (Fig. A) (Cont.)

of A-8 will engage the clutch. A reverse of either movement releases the clutch and if the movement is continued applies the brake.

Sliding gears only, as shown in Figure B, are used for all combinations of the spindle speeds, so the spindle speed is positive at these points. Therefore, if there is any slippage the belts should be tightened or the clutch adjusted as indicated on the instruction plate located on the cover to the clutch A-22.

Spindle and Cam-Lock Spindle Nose (Fig. C)

The spindle is hardened, tempered and accurately ground, leaving the front end very hard to prevent the embedding of chips and to assure permanent accuracy. It is mounted on pre-loaded super-precision ball bearings, and will require no further adjustment.

In accordance with the newest and best lathe practice, this lathe is equipped with the Cam-Lock Spindle Nose, which holds face plates and chucks true and rigid.

To mount face plates or chucks on the Cam-Lock Spindle Nose, proceed as follows:

1. Wipe off all chips and dirt from the pilot and flange of the spindle nose and of the corresponding recess and shoulder on the face plate or chuck, so that no chips remain that would otherwise prevent their running true.
2. Place the registration lines C-2 on the heads of the six Cam-Locks so as to match the corresponding lines C-1 on the outer rim of the spindle nose. Detents will hold them in these positions.
3. Lift the face plate or chuck up in line with the spindle, either by hand (resting it on a wooden block) or by using the sling of a crane, and push it onto the spindle nose.
4. Tighten the cam-locks C-3 by a clockwise turn of the wrench, pulling them up tight by hand -- it is not necessary to use a hammer on the wrench.

Spindle and Cam-Lock Spindle Nose (Fig. C) (Cont.)

When the cam-locks are tightened, the registration lines C-2 on their heads should be between the "three o'clock" and "six o'clock" positions. If any one of these does not register within this range, the mating stud C-4 in the face plate or chuck should be adjusted.

This is done by removing the hollow head retaining screw C-5, and by turning the stud C-4 one or more complete turns to the right to shorten and to the left to lengthen. Be sure to replace the hollow head retaining screw C-5.

It takes less than a minute to mount a chuck or face plate, the weight of which is within a man's ability to lift off the bench.

To remove the face plate or chuck reverse the operations. That is:

1. Unlock the cam-lock studs C-3 by turning the wrench counterclockwise until the registration lines C-2 on the heads of the six cam-locks match the corresponding lines C-1 on the flange of the spindle nose.
2. Gently tap the face plate or chuck with a lead hammer to loosen the pinch at the pilot, and then pull it away from the spindle nose. This operation also takes less than a minute under similar conditions.

The Cam-Lock Spindle Nose has been developed under the procedure of the American Standards Association (ASA-B-5-L) and sponsored by the Society of Automotive Engineers, the National Machine Tool Builders' Association, and the American Society of Mechanical Engineers, and is designated as "Lathe Spindle Nose, type D-1".

It is interchangeable with the American Standard Spindle Nose for turret and automatic lathes. Therefore, a cam-lock chuck for a turret lathe may be used on this lathe or vice versa.

The taper hole in the front end of the spindle is hardened and accurately ground for true mounting of a center sleeve, collet closers, expansion bushing arbors, etc.

Headstock Gear Train (Fig. B)

The gears in the train from the pulley to the spindle are hardened and ground. Four levers B-8 are mounted on the front of the headstock for sliding the gears into the various combinations of spindle speeds as indicated on the instruction plate B-9.

There are 18 spindle speeds in either of two ranges - 14 to 1000 R.P.M. or 21 to 1500 R.P.M. This is a sufficient range to meet the latest developments in high speed steels and tungsten tantalum carbide cutting tools.

The spindle runs in only one direction by power. However, by sliding the gears into their neutral position the spindle can be turned by hand in either direction for balancing work on a face plate, etc.

The main driving clutch should always be released by lever A-2 or lever A-8, and the spindle stopped before attempting to change spindle speeds.

A speed and feed diagram, Figure L, will be found at the back of this book.

LEAD SCREW AND FEED ROD GEAR BOX

Ratio Gear Box (Fig. B)

The ratio gear box acts as the connecting link between the gear trains of the headstock and the speed control gear box B-4 of the leadscrew and feed rod. These three gear clusters when properly connected control the rate of travel of the tool carriage per revolution of the headstock spindle.

Operation of Lead Screw and Feed Rod Gear Box (Fig. B)

To change the feed of the tool carriage proceed as follows:

- First: Select the proper spindle speed for the job to be done and set the spindle speed levers B-8 as indicated on instruction plate B-9.
- Second: As a precautionary measure move lever D-13 to its horizontal or neutral position. This disengages the clutch between the gear trains of the spindle and the feed rod and leadscrew gear box.

Operation of Lead Screw and Feed Rod Gear Box (Fig. B) (Cont.)

- Third: Find the figure on the instruction plate B-5 corresponding to the pitch of the thread to be cut, or the thickness of the chip desired when turning or boring. Place ratio lever B-2 in the corresponding notch. When lever B-2 is in the middle notch it is in neutral and the gear trains are disconnected.
- Fourth: At the right of the instruction plate is a vertical row of letters. Find the letter at the end of the row of figures containing the figure selected. Place the plunger of lever B-6 in the hole marked with this letter.
- Fifth: Engage the plunger of the rocker lever B-3 directly below the vertical column of figures containing the one selected.
- Sixth: Engage the plunger of lever B-7 in the hole designated "Thread" if thread cutting or "Feed" if turning or boring. It may be necessary to turn the lead screw or feed rod part of a revolution by hand, so as to match the sliding gears.

Use the lead screw only when cutting threads. For all other operations, use the feed rod. This will prolong the accuracy of the lead screw.

TOOL CARRIAGE

Hand Operation (Figure D)

When the knob D-21 in the center of handwheel D-22 is pushed in, the handwheel will actuate the carriage through a gear engaging the rack D-12. If desired the handwheel D-22 can be disengaged by pulling out knob D-21 and thus eliminate the effects of its momentum when thread cutting.

To move the cross slide by hand, use handwheel D-20 which is equipped with a graduated micrometer dial reading to .001" on the diameter of the work, or in millimeters when so specified. This dial may be set by loosening binder nut D-2. Handwheel D-20 engages the cross feed screw.

Should the amount of backlash in the cross feed screw nut become excessive, it may be adjusted by the two socket head screws located at the rear end of the cross slide. To make an adjustment, proceed as follows:

- First: Turn handwheel D-20 about three turns clockwise.
- Second: Loosen right-hand screw two full turns.
- Third: Tighten left-hand screw slowly and simultaneously turn handwheel D-20 clockwise until a very slight drag is felt.
- Fourth: Tighten right-hand screw.
- Fifth: Check for backlash and feel.

At the rear of the carriage the cross feed screw is enclosed in a sleeve which transmits motion from the taper bar to the cross slide.

Hand Operation (Cont.)

When the taper attachment is not used, the cross feed screw guide should be locked in place with lock bolt A-17. The guide may be moved before locking by turning the handwheel D-20.

The carriage bronze way scrapers should be periodically removed and inspected and if found excessively worn, should be replaced.

The binder screw, on the right-hand side of the cross slide, locks the slide in any predetermined position.

Cross Slide Positive Stop (Fig. D)

The precision threading and diameter stop D-18 has been provided to control the positions of the cross slide.

It is applicable at any position of the cross slide. The positive stop is set by placing the cross slide in the position at which it is to be stopped. Then raise the lever D-17. By varying the amount of pressure on this lever the stop can be locked positively or permitted to slip under strain applied at handwheel D-20. Once the lever D-17 has been set, the cross slide can be withdrawn away from the stop for one-half inch at which time the stop for withdrawal becomes effective.

Compound Slide Rest (Fig. D)

The tool rest slide D-5 is mounted on top of the cross slide. It is provided with a swivel D-3, graduated to degrees of an arc. By loosening bolt D-4 and the corresponding bolt on the other side of the swivel, the slide can be swung around, located and clamped into any convenient position for the cutting tool or for turning bevels or boring taper holes.

The handwheel D-8 for operating the tool rest slide feed screw is equipped with a micrometer dial, adjustable by loosening binder nut D-7. This dial reads to .001" on diameter of work, or in millimeters if so specified. The micrometer dial will be found useful for quickly adjusting the tool a predetermined amount when turning, boring or thread cutting either crosswise or sidewise, depending on the setting of the graduated swivel.

It can also be used for cutting multiple start threads. Move the thread tool sidewise an amount corresponding to the pitch of the thread for each start.

The binder screw, on the right-hand side of the tool rest slide D-5, locks the compound tool rest slide in any predetermined position.

Adjustment of Carriage Gibs (Fig. D)

If, after long service, the slides of the compound rest require adjustment, withdraw the gib screw at the rear of the compound rest a fraction of a turn and follow it up with the small gib screw D-6 at the front of the compound rest, thereby advancing the taper gib in the seat. Repeat this adjustment in easy stages until the side play has been eliminated, but the slides should still move freely in their mating members.

A similar adjustment may be made of the cross slide by withdrawing the gib screw at the rear of the cross slide and following it up with the gib screw D-9 at the front.

Carriage Clamp (Fig. D)

When using the compound slide rest for turning or boring or the cross slide for facing, it is essential that the carriage remain in a fixed position. The carriage clamp bolt D-10, operated by the tool post wrench, locks it securely. Do not forget to unclamp the carriage before applying the longitudinal power feed.

Forward and Reverse Clutch (Fig. D)

A double end clutch transmits power from the ratio box to the feed gear box B-4 and thru the leadscrew or feed rod to the carriage. To make the carriage travel by power toward the headstock, lever D-13 must be in its lowest position. By swinging lever D-13 to its highest position the direction of the carriage is reversed. When lever D-13 is in its horizontal position the clutch is disengaged and the leadscrew and feed rod are both stationary.

In order to assure correct timing between the headstock spindle and the leadscrew after they have been disengaged for the reversal of the carriage, this clutch is of the single tooth type. A synchronizing device has been incorporated in the mechanism so that the clutch can be engaged without danger of breaking at any combination of spindle speeds and carriage feeds within the requirements of good shop practice. A little care must be taken by the operator in using lever D-13, however. Swing it into engagement, giving the synchronizing device time to function (in the same manner as the gear shift in an automobile should be operated). Be sure the clutch is fully engaged before the tool begins to cut.

Stop Collars (Fig. D)

Two stop collars E-8 are mounted on spline shaft D-11. By clamping these collars in suitable positions the carriage will, when traveling in either direction, push the single tooth clutch out of engagement, which stops the carriage in the predetermined position. The screw thimble D-23 with a lock nut may be used for fine adjustments.

Power Operating Using the Feed Rod (Fig. D)

To operate the carriage by power, pull lever D-19 upwards. This transmits power to the rack D-12 and moves the carriage toward or away from the headstock, depending upon the position of lever D-13 as explained in a preceding paragraph.

To operate the cross slide by power, pull lever D-16 upwards. This transmits power to the cross slide screw and causes the cross slide to move toward the work or away from it, depending upon the position of lever D-13. A 45° bevel may be cut by pulling up both levers D-19 and D-16 simultaneously.

To stop the power feeds push the lever D-16 or D-19, whichever is in use, downwards. This disengages the clutch.

Thread Cutting (Fig. D)

Lever D-15 is used for engaging the leadscrew nut. It is interlocked with lever D-19 and cannot be engaged unless the latter is in its lowest disengaged position. Also when lever D-15 is set for leadscrew, lever D-19 cannot be pulled upward engaging the feed rod clutch. This prevents the accidental simultaneous engagement of both the leadscrew and feed rod, and the resultant damage to the mechanism.

The leadscrew thread is of comparatively coarse pitch to insure durability. To engage the two halves of the nut, it is necessary to move the carriage back and forth a slight amount by hand, thereby easing the half nut into engagement without danger of raising any burrs on the edges of the leadscrew thread and thereby impairing the accuracy.

When lever D-15 is in its 2 o'clock position the leadscrew is engaged and when it is in its 10 o'clock position, as shown in Figure D, the leadscrew is disengaged.

On Figure O (or O_n), at the back of this book, is the formula for figuring change gears when cutting special threads. Figure Q gives the index for dimetrical pitches.

Thread Cutting Dial (Figures D, M and N)

Thread cutting dial D-14 is used in cutting multiple-start threads. It is in constant mesh with the leadscrew. It indicates the movement of the carriage at a ratio of one complete turn of the dial for a $\frac{1}{4}$ " movement of the carriage. Complete information on using this dial is given on the thread chasing dial diagram, Figure M and N (or Nm) at the back of this book.

METRIC EQUIPMENT

The metric lathe is equipped exactly as the English except that a 6 m/m leadscrew is supplied together with a set of 8 change gears.

With these 8 change gears, the lathe will cut all standard metric leads from .5 to 21 m/m.

It should be noted that the metric index plate does not read in order of magnitude, as does the English plate, but requires the same method of setting the three levers.

The metric index plate, although the same size as the English, is sub-divided differently. At the left of the plate the gears are listed for cutting the various leads in m/m, and the direct reading by the setting of the three levers is the same as the English lathe.

The leads are approximately 6.25 times the feeds in all cases.

The chart on Figures Nm, Om, Pm, Sm and Tm apply particularly to metric lathes.

TAILSTOCK

(Fig. E)

The tailstock spindle has a No. 3 New American Standard Taper hole at the front end for holding centers, drill chucks, etc., in the conventional manner. It also has a tang driving slot so that twist drills can be used to full advantage and with safety without turning in the taper hole.

There are graduations on top of the spindle for convenience in drilling holes to predetermined depths. On the front side of the spindle is a scribed line for setting the cutting tool to the correct center height.

Tailstock (Fig.E) (cont.)

An end ball bearing thrust relieves the end pressure of the spindle screw.

The spindle key is of generous proportions, designed to resist the twisting strain when drilling and also acts as an efficient spindle clamp. It is actuated by handle E-15.

The tailstock is mounted on its base. Sidewise adjustment of the tailstock can be made with bolt E-17, and the corresponding bolt on the other side. A zero line on the left-hand side of the base indicates true alignment with the headstock spindle.

Two clamps hold the tailstock rigidly to the bedways. Clamping and unclamping are accomplished by a single lever, E-19, which actuates both clamps simultaneously for either light or heavy duty work. Spring loaded ball bearings under the tailstock will support nearly all of its weight so that when the binder is released very little effort is required to reposition it on the bed.

Instructions for adjusting the tailstock clamps are shown on a plate attached to the tailstock base.

OPERATION OF THE LATHE
(Fig. E)

- First: Release all driving clutches by depressing levers E-22, E-21 and E-20 to their lowest positions and place lever E-16 in its horizontal position.
- Second: Swing lever E-13 counter-clockwise to its 10 o'clock position, thereby releasing the leadscrew nut.
- Third: Place the four spindle speed levers E-6 in position to give the speed required. Do not make the spindle speed too high the first time the lathe is operated. It is safer to make the trial run with a moderate spindle speed. Do not change the spindle speed when the spindle is in motion.
- Fourth: Place levers E-2, E-3, E-4 in position to give the required lead or feed. Then place lever E-5 in position for either leadscrew or feed rod, whichever is to be used.
- Fifth: Locate the stop collars E-8 to suit the job, or for the trial run allow about 6" on either side of the

Operation of the Lathe (Cont.)

tool carriage. Then move the carriage back and forth by hand until it almost touches the stop collars, making sure that the tailstock is out of the way.

Sixth: A -- For thread cutting

Swing lever E-13 to the 2 o'clock position, moving the carriage gently back and forth a small amount by hand so the half nut will be eased into engagement with the leadscrew. Be sure lever E-13 has been swung beyond its detent, thereby locking it in place. Only use the leadscrew when cutting threads.

B -- For turning or boring

Lift lever E-22. This engages the feed rod clutch.

C -- To engage the cross slide traverse

Lift lever E-21.

Seventh: To start the headstock spindle revolving, swing lever E-7 to the right, or lift lever E-20, engaging the primary drive clutch.

Eighth: To start the tool carriage moving to the left and/or the cross slide moving outwards, swing lever E-16 gently downwards, giving the synchronizing device a chance to function while engaging the clutch. Be sure the clutch is fully engaged before the tool begins to cut.

Swinging lever E-16 into its highest position reverses the direction of travel of the carriage and/or cross-slide.

Ninth: When the job is finished place all levers on the carriage in their neutral positions and press the motor switch stop button at the close of the working period.

STORAGE

If you have occasion to store this lathe for any length of time, it should be cleaned and carefully slushed with a heavy grease on all exposed unpainted surfaces.

Storage (Cont.)

The storage place should be dry and the temperature reasonably uniform, as sudden changes of temperature in an unheated warehouse will cause condensation of the moisture in the air and induce rusting.

ADDITIONAL EQUIPMENT
(Fig. G and H)

Expansion Arbors and Bushings (Fig. G-a)

The expansion arbor and bushing equipment includes one draw-in sleeve and sizes and quantities of arbors and bushings as ordered.

The taper shank of the arbor is mounted in the taper hole of the headstock spindle and secured with the draw-in sleeve.

Step Chucks (Fig. G-b)

Step chuck equipment includes one step chuck seat bushing and step chucks and closers in quantities ordered.

When received the faces of these chucks are blank and must be "stepped out" or recessed to suit the job on hand. By putting a piece of wire that fits in the center hole of the chuck, the chuck can be drawn back and held securely in its closer during the "stepping out" operation.

Follow Rest (Fig. G-c)

To mount the follow rest, loosen four screws in the sides of the carriage bridge and set slots in rest on to the screws. Tighten the four screws.

Collet Mechanism (Fig. G-d)

The collet mechanism equipment includes one collet closer, one collet draw-in sleeve and sizes and quantities of spring collets as ordered. Collet racks as shown on Figure G-d are also available.

Put a few drops of oil in the thread of the draw-in sleeve occasionally.

Micrometer Carriage Stop (Fig. G-e)

The micrometer stop can be clamped at either end of the tool carriage. When used for facing or similar operations the carriage is held against the micrometer stop by hand, or it can be locked in position with the carriage clamp bolt D-10.

When the micrometer stop is used as a stop in conjunction with the power longitudinal feed of the tool carriage, the stop collar E-8 should be set so that the clutch disengages, and the carriage stops just before it hits the micrometer stop. The carriage is then moved by hand up to the micrometer stop.

Ball Bearing Taper Attachment (Fig. G-f)

The taper attachment is mounted at the rear of the bed upon a finished pad having two T-slot and extending the full length of the bed. It can be located and securely clamped to the bed in any position within the range of travel of the tool carriage.

At both ends of the taper bar bracket G-9 are scales for setting the taper bar at the required angle. The scale G-3 at one end is graduated to a range of 20° included angle, and the one at the other end, G-1, to $4''$ taper per foot or in millimeters per decimeter if in metric measure. Thus it is possible to turn, bore or thread within these ranges and up to $15''$ in length.

As previously described, the cross feed screw guide is mounted at the rear of the tool carriage for the purpose of carrying the taper bar shoe G-8 and to transmit the motion from the taper bar G-7 to the cross slide.

Ball Bearing Taper Attachment (Fig. G-9)

Mount ball bearing taper attachment on plain machine as follows:

- (1) Remove cap from cross feed screw bracket on rear of carriage and remove ball bearing nut. Remove cross feed screw bracket and ball bearing.
- (2) On cross feed screw, assemble bearing retaining nut furnished with attachment. Assemble ball bearings (Mounted DF) and lock securely with retaining nut. Assemble over ball bearings the cross feed screw guide furnished with the attachment, locking securely with retaining nut previously mentioned.
- (3) Assemble cross feed screw bracket to carriage, and bolt securely after the center of the cross feed screw and cross feed screw nut are in alignment, and the attachment is parallel with the taper bar. Then drill and ream for two dowel pins in cross feed screw bracket.
- (4) Set taper bar to zero position and, place bar shoe into the center of taper bar. To engage the shoe to the taper attachment place the tool carriage in position so that the hole in the guide will align with the hole in the shoe. Lock swivel stud nut securely to shoe with T-wrench provided after the taper bar has been set to the desired angle.

Ball Bearing Taper Attachment (Cont.)

(5) Remove lock bolt bracket located in rear of taper attachment and measure the distance from the pad to the center of the tapered hole in the cross feed screw guide. Then remachine the back side of the lock bolt bracket to the same dimension obtained. Assemble lock bolt bracket. When taper turning lock bolt must be disengaged.

(6) On the rear edge of the taper bar, turn the two square headed eccentric binders G-6 a half turn counter-clockwise, unlocking the taper bar. Use knob G-5 to set the taper for the desired angle. Then reclamp the binders G-6.

(7) Before taking a chip run the carriage by hand all along the work, making sure that the taper bar shoe does not run out of the slot in the taper bar which the cut is being made.

(8) When turning straight work, disengage shoe and leave in taper bar. Also engage lock bolt located in rear of taper attachment.

Turning 45° Bevels

The compound slide rest is usually used for turning and boring tapers beyond the capacity of the taper attachment. By simultaneously engaging the longitudinal and cross power feeds of the tool carriage (done by lifting both lever E-22 and lever E-21) it is possible to turn or bore 45° bevels to the center line without use of the taper attachment.

Turning Bevels Greater than 45°

By coupling the taper attachment and the combination described in the preceding paragraph, the 45° bevel, obtained by the two right angle slides, can be increased or decreased about 5° in increments to suit the requirements.

The readings on the taper attachment scales are graduated so as to express the included angles produced with a non-revolving carriage cross feed screw. Therefore the amounts indicated cannot be added to or deducted from the 45°. To obtain the correct angular taper bar setting when the cross feed is in use, consult the chart on the next page.

This table gives the various angles obtainable at different settings of the taper attachment using the longitudinal and cross power travels of tool carriage.

<u>Setting</u>	<u>Angle greater than 45°</u>	<u>Angle less than 45°</u>
1°	45° - 30'	44° - 30'
2°	45° - 59'	43° - 59'
3°	46° - 28'	43° - 28'
4°	46° - 56'	42° - 56'
5°	47° - 24'	42° - 23'
6°	47° - 52'	41° - 49'
7°	48° - 19'	41° - 16'
8°	48° - 45'	40° - 41'
9°	49° - 12'	40° - 5'
10°	49° - 38'	39° - 28'

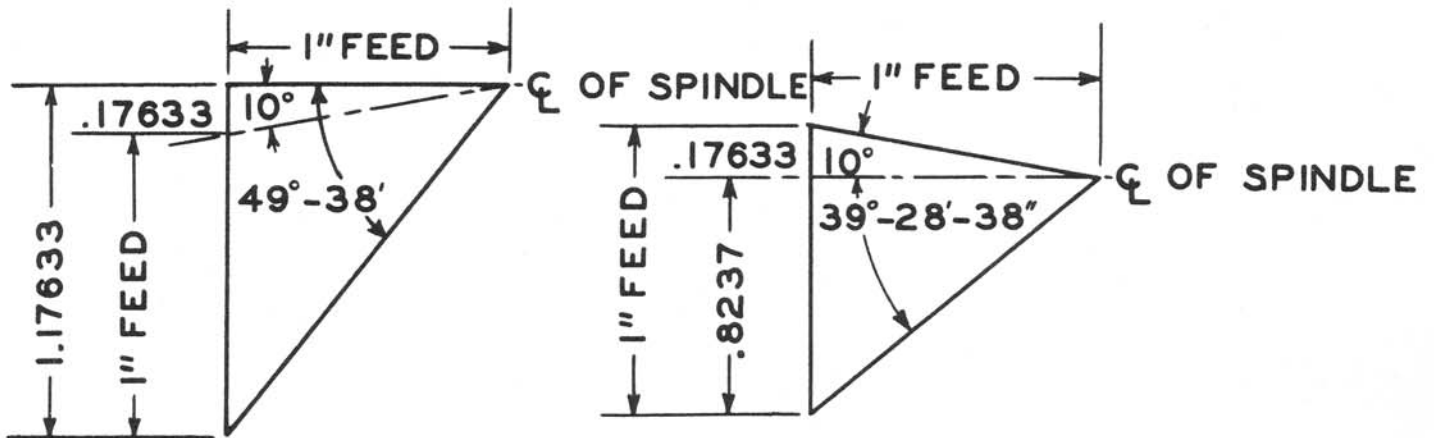

Multiple Indexing Face Plate (Fig. H-a)

The multiple indexing face plate is mounted on the Cam-Lock Spindle Nose in the same manner as a face plate.

It is used for cutting multiple start thread, etc. A 60-notch index plate is usually furnished, but special index plates with notches to suit requirements can be furnished.

Carriage Spacing Attachment (Fig. H-b)

Directions for mounting:

Clamp the outboard support H-9 to the "V" way of the lathe bed using the two bolts H-8. Insert the end measure trough H-4 and bushing H-6 in the outboard support, and place the dial indicator bracket H-1 on the right-hand horn of the

Carriage Spacing Attachment (Cont.)

tool carriage, lining the trough H-4 parallel with the ways of the bed. Then transfer the bolt holes of the bracket H-1 into the carriage horn, tap the holes and clamp bracket H-1 on the carriage horn.

Directions for use:

Set the micrometer H-3 and the dial indicator H-2 to zero, clamping the adjustable measuring contact H-5 in position with binder H-7, for the first shoulder or groove. Then extend the micrometer H-3 and add the necessary end measures for the required spacing, using the dial indicator as an anchor only, for subsequent shoulders or grooves.

This device is used for accurately facing shoulders and spacing grooves in shafts, etc.

Pump and Piping Equipment (Fig. H-c)

The pump for cutting oil and compounds is a self-contained motor driven unit H-10. It is mounted on the pad A-15 at the rear of the bed. The flexible hose H-11 with its nozzle H-12 are attached to the carriage.

The motor "on" and "off" switch is located at the headstock end of the machine.

Do not use solutions that will tend to clog the lubricating oil grooves in the tool carriage and its apron.

Speed Reducer (Fig. H-d)

For work where the coarseness of the lead of the thread to be cut is beyond the normal capacity of the leadscrew, a speed reducer should be used. It can also be successfully employed in conjunction with the cutter relieving attachment when the lowest spindle speed is too fast to obtain the correct surface speed of the work.

The speed reducer has a built-in planetary gear train which reduces the speed of its work dog driver six to one in relation to the headstock spindle and leadscrew. Thus it is possible to cut threads six times coarser in lead than indicated on the tabulated instruction plate B-5. The table, Figure R at the back of this book, gives the range of pitches and leads available when the speed reducer is used.

The speed reducer is particularly intended for coarse leads. If it becomes necessary to use it for cutting threads of less than .100" lead, the exact location of the carriage, at the time the single tooth clutch is engaged for forward travel, becomes very critical. It should not vary more than 1/20 of the lead even if it becomes necessary to use a dial indicator to control the stop position on the return travel of the carriage.

The single tooth clutch should not engage immediately as its lever is actuated. The distinct click heads when the clutch teeth engage should take place when the selected numeral (referred to on the next page) is passing out of the index zone. The clutch lever should be actuated when the two clutch teeth are about 180° apart. This relationship can be obtained by a slight change in the stopping position on the return travel of the carriage.

The speed reducer is shipped with the rotor H-19 and the stator H-20 locked together with the slotted square headed bolt and nut H-15 in the hole H-17, making the reduction gears inoperative. If it is mounted on the headstock spindle in this condition without the bed plate H-14, it can be used as a conventional work driver with a 60-notch index plate H-21 for cutting multiple threads when the required lead of the thread and surface speed of the work are within the normal capacity of the lathe. When so used, the small lever H-22 is used to lock the index plate in position.

The speed reducer is mounted on the Cam-Lock Spindle Nose in the same manner as a face plate, which was described in a preceding section of this book.

After the speed reducer is mounted, place the bed plate H-14 on the bed directly below it. Then revolve the headstock spindle until the lug in the rim of the speed reducer matches the notch in the bed plate. Clamp the bed plate to the bed and transfer the square headed bolt and nut H-15 from hole H-17 to its position in the bed plate as shown in illustration H-d. The nut and bolt H-15 presses the disc H-13 against the lug in the rim of the speed reducer, clamping the stator H-20 to the bed plate. This makes the reduction gears operative.

When using the speed reducer for thread cutting, whether left or right hand, be sure the carriage stop E-8 is set so that on the return travel, the carriage will stop when the thread tool is a predetermined distance beyond the end of the thread. This will disengage the single tooth clutch so that the lead-screw is in the same position for the start of each cut and there will not be any danger of "crossing" the threads. The carriage may be stopped at any position after the cut is made, but each cut must be started at the proper point.

One, two, three or six "start" cuts may be made by using the 6 to 1 reduction on the face of the rotor for this purpose. By operating the carriage reverse lever E-16 when the proper numeral is within the index zone, indicated by the groove H-18, these starts can be obtained without using the index plate.

For single starts engage the reverse clutch by means of lever E-16 when any predetermined number passes the index zone. If, for example, number 3 is selected as the starting numeral, this number must always be used until the job is completed.

For double starts, operate the carriage reverse lever E-16 as every third numeral, such as 1-4, 2-5, or 3-6 passes the index zone.

Speed Reducer (Cont.)

For triple starts operate carriage reverse lever E-16 at every other number, such as 1-3-5 or 2-4-6.

For sextuple starts operate the carriage reverse lever E-16 at each successive numeral.

Special change gears and index plates can be furnished to cut threads which have not been tabulated but are within the range of the lathe.

To use the speed reducer as a conventional work driver, lock the rotor H-19 and the stator H-20 together. Turn the former until the registration line H-16 of the rotor corresponds with that of the stator. Then remove the square headed bolt and nut H-15 from the bed plate and place it in the hole H-17.

Relieving Attachments

Radial and Side Relieving Attachments are available as additional equipment, either separately or a combination of both. A complete description, charts and pictures of these attachments are included in all instruction books covering lathes so equipped.

To mount the Radial and Side Relieving Attachment Drive, proceed as follows:

- (1) Set main drive clutch lever A-2 in the engaged position.
- (2) Remove driving belts, disconnect leads to control panel and remove end guard from machine.
- (3) Remove main drive sheave and clutch bracket.
- (4) Remove four screws from retaining cap and disassemble clutch driving sleeve and ball bearings from clutch bracket.
- (5) Reassemble driving sleeve and ball bearings in the new clutch bracket furnished with the relieving attachment. The retaining cap should hold bearings in place without end play - fit cap if necessary. Assemble new bracket to machine and replace driving sheave.
- (6) Remove the spacing sleeve from the driving shaft in ratio box directly under lathe spindle and assemble gear G16-60-16 in its place.
- (7) Assemble gear drive bracket to pulley clutch bracket. With gear G16-119-1 in place, adjust bracket position to obtain .004" to .008" backlash between gears, and dowel drive bracket in place.
- (8) Assemble new end guard and replace belts and cabinet leg cover.
- (9) Connect wiring to new control box.

Relieving Attachment

- (1) Remove chip guard on rear of cross slide.
- (2) If attachment is applied to a plain machine, assemble cross feed screw to cross feed screw guide in same manner as described under taper attachment.
- (3) Assemble radial relieving attachment to carriage, and bolt securely in same manner as described under taper attachment.

Set taper bar to zero position and engage shoe to the relieving attachment in same manner as described under taper attachment.
- (4) Remove lock bolt bracket located in rear of cam block and fit in same manner as described under taper attachment.
- (5) When taper relieving or turning lock bolt must be disengaged.
- (6) Assemble the special chip guards furnished on rear of cross slide.
- (7) Attach the universal joints of the telescopic drive shaft one end to the projecting gear stud in the drive bracket and the other universal joint to the gear stud in the cam slide bracket.
- (8) Make sure that the forks of the two halves of the universal joints that are attached to the apposite ends of the telescopic shaft are in alignment. This is very important as otherwise the camshaft in the relieving attachment will not revolve at uniform rate of speed - it will be gaining speed during one-half of a revolution, and losing speed on the other half.
- (9) Turn the telescopic shaft by hand a few times to make sure that everything is in proper order.
- (10) Unscrew the retaining nut and withdraw the camshaft. Insert the selected cam and reassemble the cam shaft.
- (11) Attach the selected change gears and close the change gear cover.
- (12) Lubricate thoroughly.
- (13) When radial relieving attachment only is used, lock bolt must be engaged.
- (14) When radial relieving and taper attachments are used in combination, the taper bar shoe and its stud should be securely locked in the hole provided in bottom side of cross feed screw guide in same manner as described under taper attachment.
- (15) For straight turning without relieving disengage cam roll from cam by moving cam release lever, mounted on top of cam block to mid position.
- (16) The taper shoe should be disengaged in same manner as described under taper attachment.

Relieving Attachment (Cont.)

To mount the side relieving attachment, proceed as follows:

- (1) Bolt adapter plate to the side relieving attachment bracket.
- (2) Clamp attachment to the rear of the bed.
- (3) Align relief rod with hole in relief rod bracket that sets on the rear of the carriage.
- (4) Tap 2 - 3/8" holes into the top of the carriage. Locate holes from relief rod bracket.
- (5) Bolt bracket in place.
- (6) Attach the universal joints and telescopic shaft.
- (7) The attachments are now ready for operation, but it is well to oil all running bearings and slides and run the attachment idle for a few minutes, making final adjustments before putting them to work.

Oversize Steady Rest

This is of the same design as the standard steady rest illustrated on Figure F, except it has a 6" capacity instead of 4-1/2". It clamps solidly to the ways of the lathe bed, is very rigid and can be adjusted quickly.

Other Additional Equipment

In addition to the equipment described here, the following items can be supplied, to order only: Additional centers, Cushman collet chucks, drill chucks, plain and elevating tools, additional tool post and translating gears.

SPECIFICATIONS

RANGE:

*Center distance, maximum	30", 54"
Swing over bed	14-1/2"
Swing over carriage	8"
Steady rest capacity	4-1/2"
Follow rest capacity	2-1/4"
Tool post takes tool	1/2" x 1"
Spindle center to floor	43"
Spindle center to top of bed	7"
Center of bed V to center of flat	11"

*Longer center distances available by special arrangement.

SPECIFICATIONS (Cont.)HEADSTOCK SPINDLE:

Special alloy steel, hardened and ground; bearings preloaded super-precision anti-friction; spindle supported in two heavy bearings at the nose end, and a third bearing at the outer end.	
Hole through spindle	1-1/2"
Taper hole in spindle (New American Standard)	No. 5
Taper hole in center adapter (New American Standard)	No. 3
Cam-lock spindle nose (flanged)	Type D-1
Collet capacity (draw-back), maximum	1"

TAILSTOCK SPINDLE:

Diameter	2-1/4"
Maximum travel	5-1/2"
Taper hole (New American Standard)	No. 3
Spindle graduated for 5" by 16ths	

SPINDLE SPEEDS:

18 spindle speeds in geometrical progression, either one or two ranges.	
Low range, rpm	14 to 1000
Upper range, rpm	21 to 1500
Driving pulley supplied with correct diameter to produce one range or the other as desired.	
Multiple V-belt drive	3 belts

FEEDS, with QUICK CHANGE MECHANISM (60 changes):

Carriage longitudinal, per revolution of spindle	.0025" to .152"
Carriage cross, per revolution of spindle	.0025" to .152"
Micrometer dials graduated in half thousandths	

THREADING, with QUICK CHANGE MECHANISM (60 changes):

Threads per inch	1 to 60
------------------	---------

REGULAR EQUIPMENT:

Includes geared head; motor drive arrangement with motor base, motor pulley, 3 multiple V-belts, belt guard, conduit and wiring; built-in push button station; attaching and testing electrical equipment, but WITHOUT motor and starter; leadscrew reverse mechanism with automatic stop in both directions of carriage travel; automatic lubrication for all main units; all shafts including main spindles mounted on anti-friction bearings, main spindle on preloaded adjustable bearings; main clutch and spindle brake multiple disc type running in oil; Cam-lock spindle nose; compound rest with drop forged steel tool slide; cross slide positive stop; round tool post; steady rest; oil and chip pan; centers; large and small face plates; knock-out rod; set of wrenches.

KEY TO FIGURE A

Front and Rear Views

1. Rocker lever
2. Main drive clutch lever
3. Carriage stop collars
4. Forward and reverse clutch shaft
5. Leadscrew
6. Feedrod
7. Leveling screw
8. Main drive clutch lever
9. Carriage and apron oil gage
10. Motor housing
11. Feed rod and leadscrew gear box oil gage
12. Motor push button switch
13. Rocker oil cup
14. Knockout rod
15. Pump pad
16. Cross slide chip guard
17. Cross slide screw sleeve binder
18. Taper attachment shoe
19. Taper bar
20. Headstock oil filter
21. Headstock oil gage
22. Main drive clutch
23. Main drive pulley (Inside of guard)
24. Electrical equipment housing

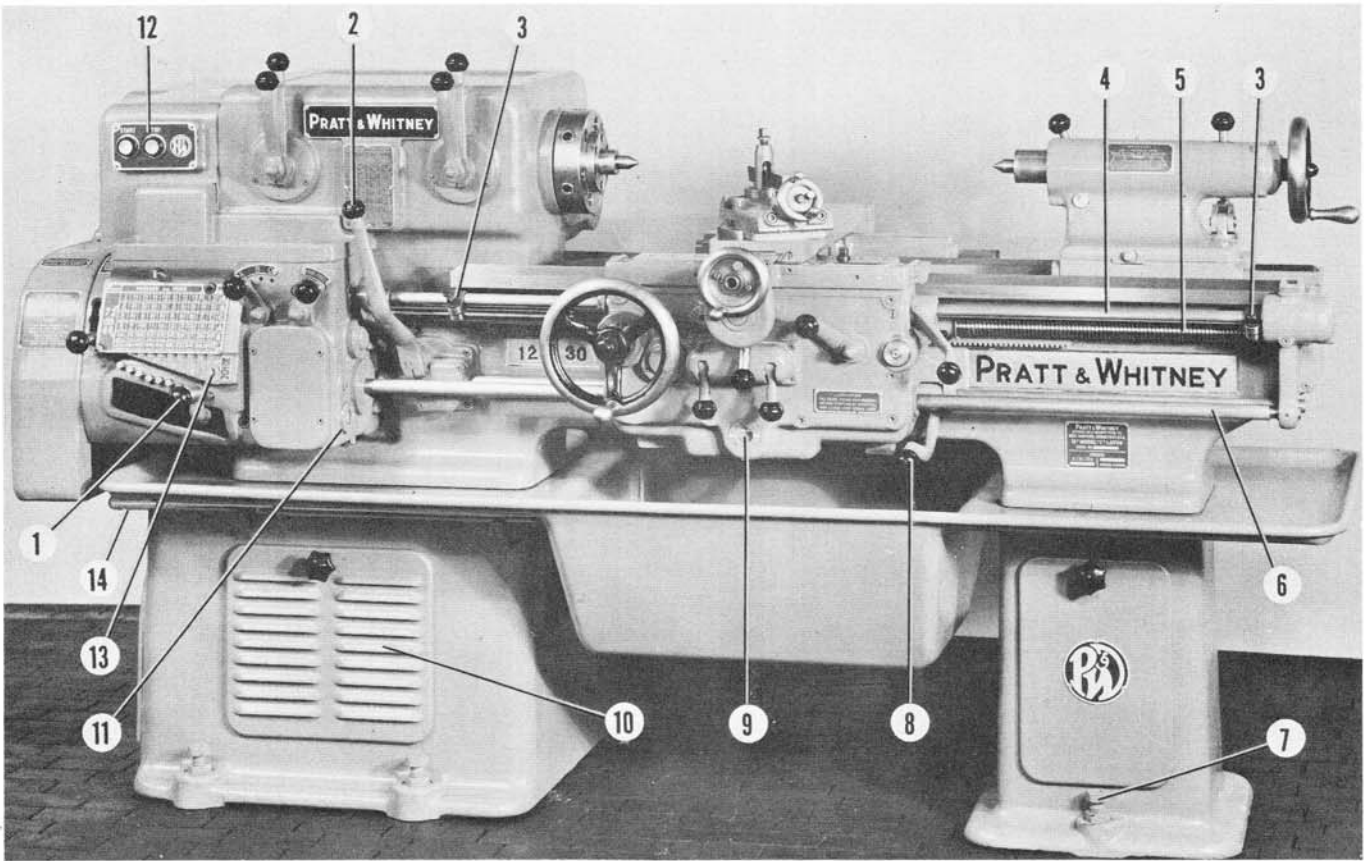

FRONT VIEW

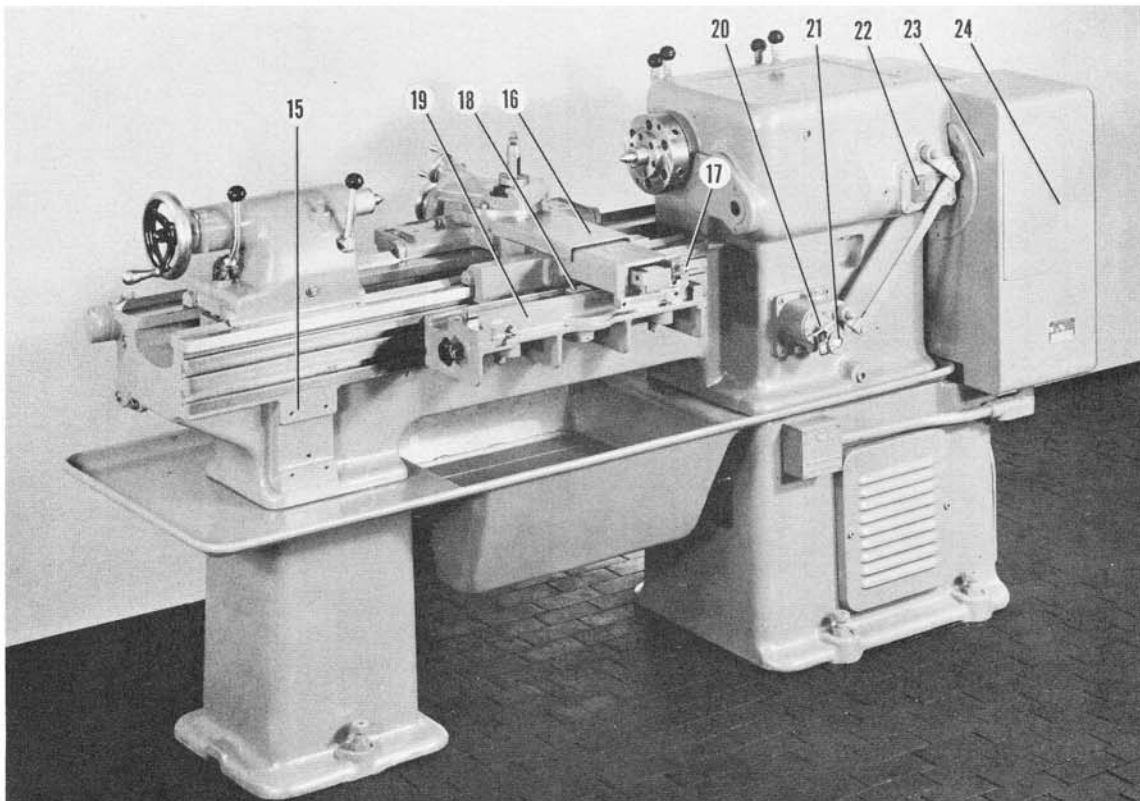

REAR VIEW

FIG. A

KEY TO FIGURE B

Headstock and Feed Rod and Leadscrew Gear Box

1. Change gear guard
2. Ratio lever
3. Rocker lever
4. Feed rod and leadscrew gear box
5. Feed and thread instruction plate
6. Selector lever
7. Thread and feed shift lever
8. Spindle speed levers
9. Spindle speed instruction plate

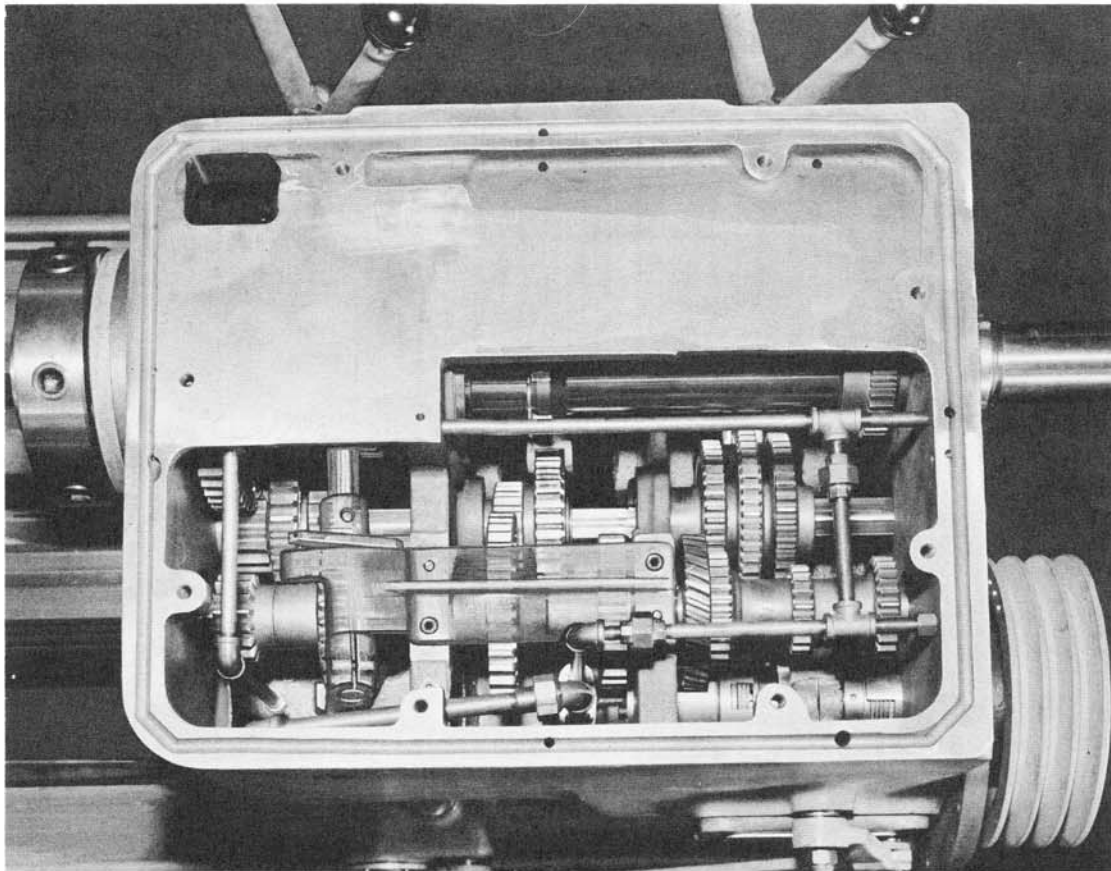
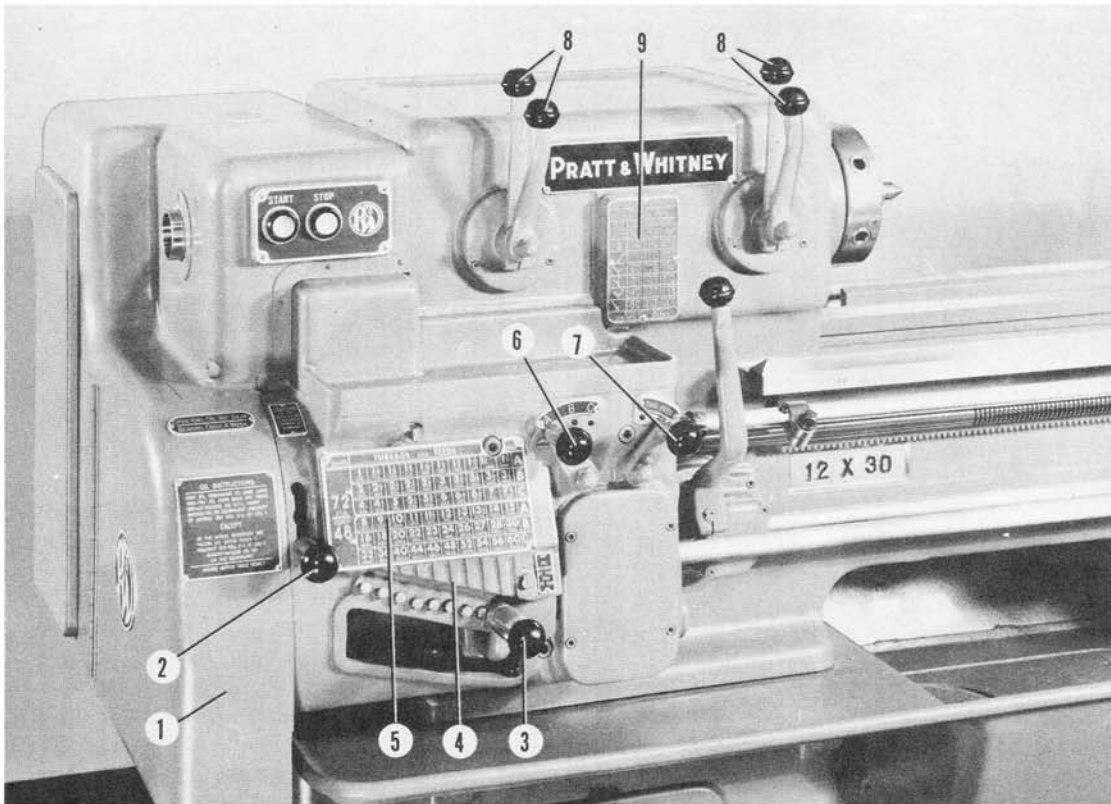

THE HEADSTOCK

FIG. B

KEY TO FIGURE C

Cam-Lock Spindle Nose

1. Registration lines on spindle nose
2. Registration lines on Cam-Locks
3. Cam-Locks
4. Cam-Lock mating stud on chuck or face plate
5. Hollow head retaining screw

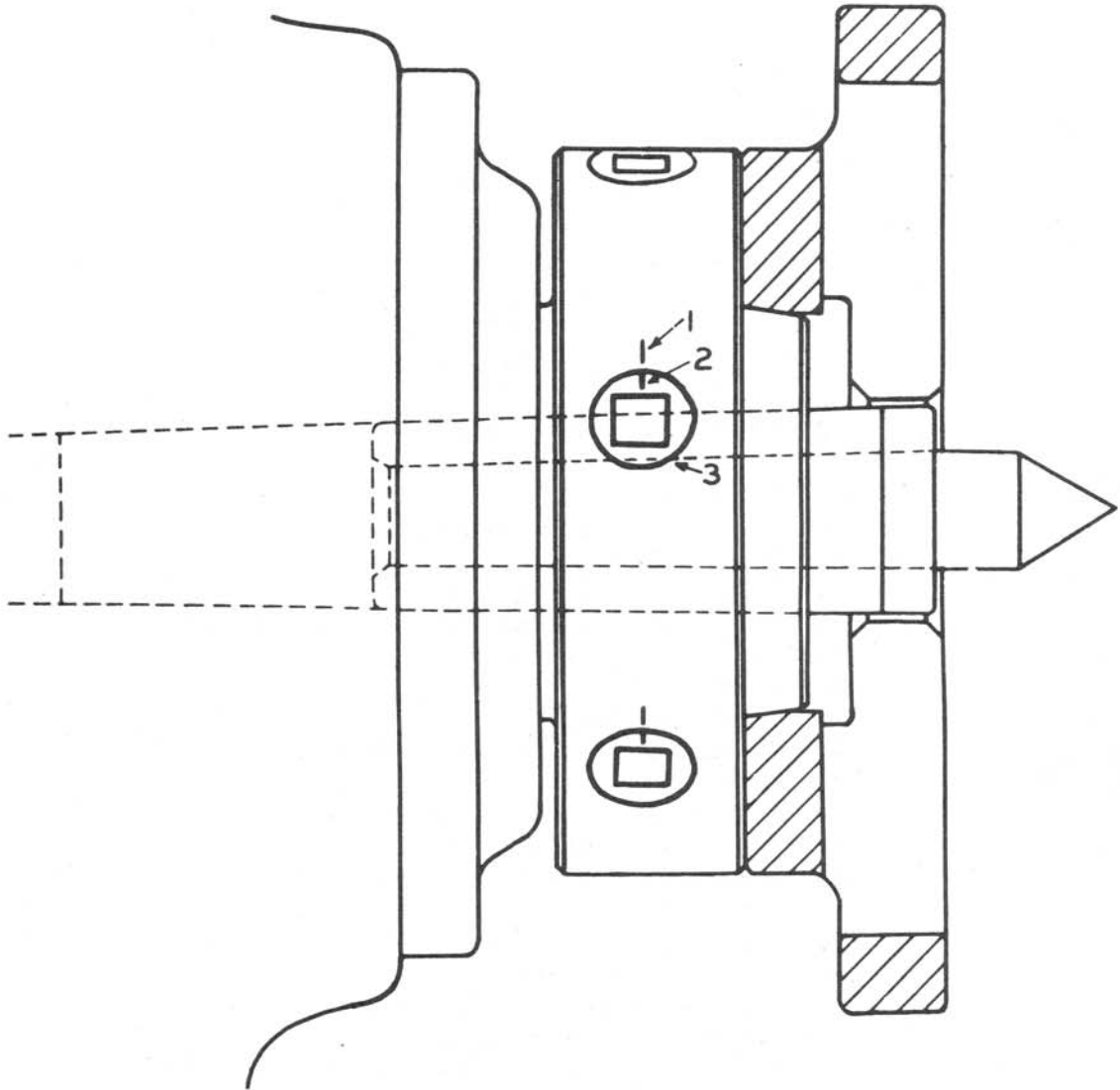

CAM-LOCK
SPINDLE NOSE

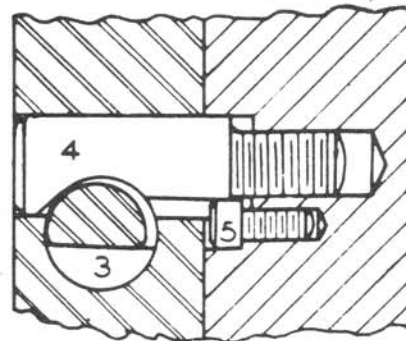
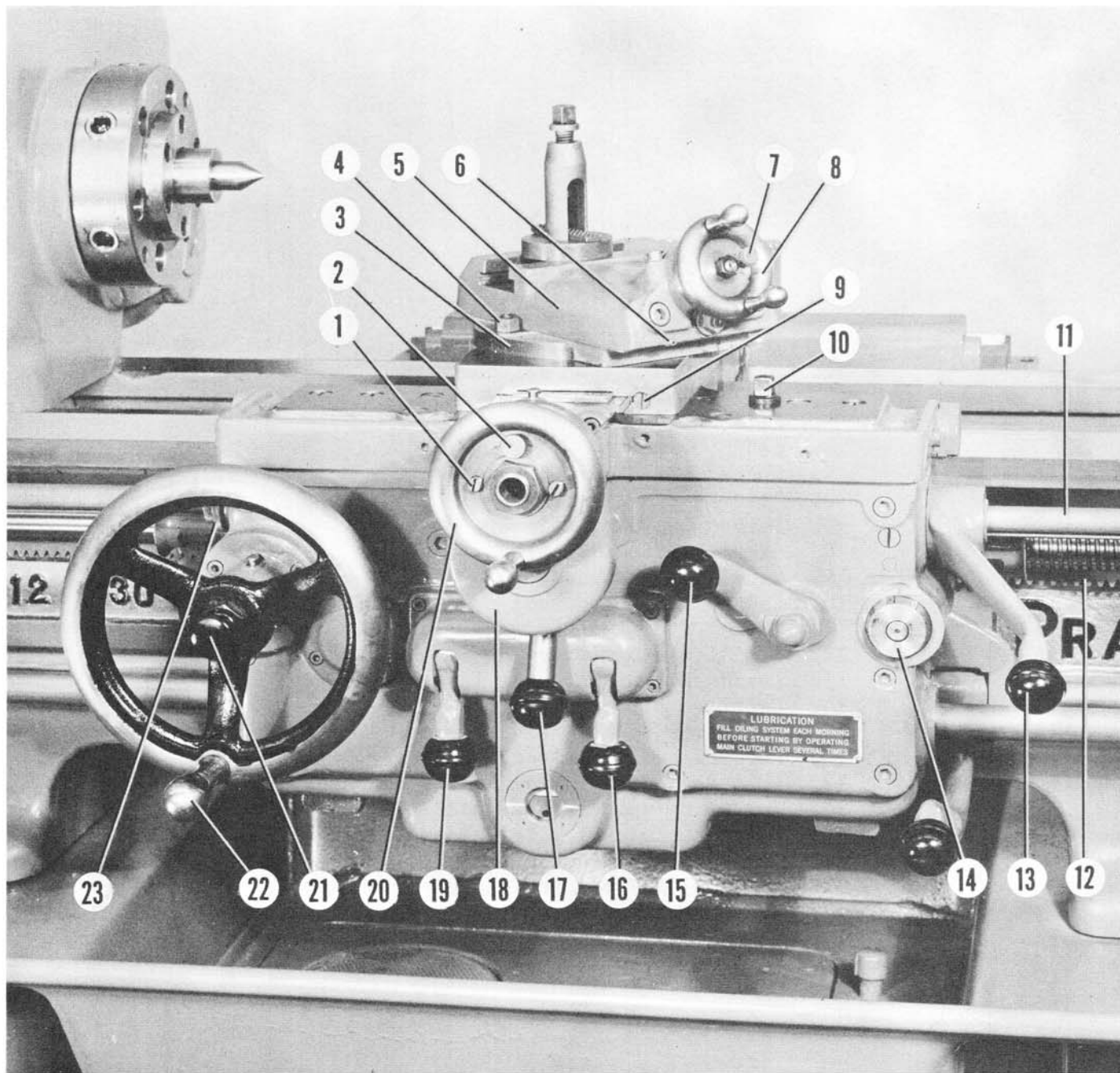

FIG. C

KEY TO FIGURE DApron and Carriage

1. Friction binder screw
2. Cross slide micrometer dial binder
3. Tool rest swivel
4. Tool rest swivel binder
5. Tool rest slide
6. Tool rest slide gib screw
7. Tool rest slide micrometer dial binder
8. Tool rest slide handwheel
9. Cross slide gib screw
10. Carriage clamp
11. Forward and reverse clutch shaft
12. Rack
13. Forward and reverse clutch lever
14. Thread chasing dial
15. Leadscrew nut engaging lever
16. Cross slide feed rod clutch lever
17. Positive stop lever
18. Positive stop housing
19. Carriage feed rod clutch lever
20. Cross slide handwheel
21. Carriage handwheel disengaging knob
22. Carriage handwheel
23. Adjustable carriage stop with lock nut



THE APRON AND CARRIAGE

FIG. D

KEY TO FIGURE E

Operating Levers

1. Motor push button switch
2. Rocker lever
3. Ratio gear lever
4. Selector lever
5. Thread and feed shift lever
6. Spindle speed levers
7. Main drive clutch lever
8. Carriage stop collars
9. Carriage handwheel
10. Cross slide handwheel
11. Tool rest slide handwheel
12. Positive stop lever
13. Leadscrew nut engaging lever
14. Carriage Binder
15. Tailstock spindle clamp lever
16. Forward and reverse clutch lever
17. Bolt for adjusting tailstock alignment
18. Tailstock spindle handwheel
19. Lever for clamping tailstock to bed ways
20. Main drive clutch lever
21. Cross slide feed rod clutch lever
22. Carriage feed rod clutch lever

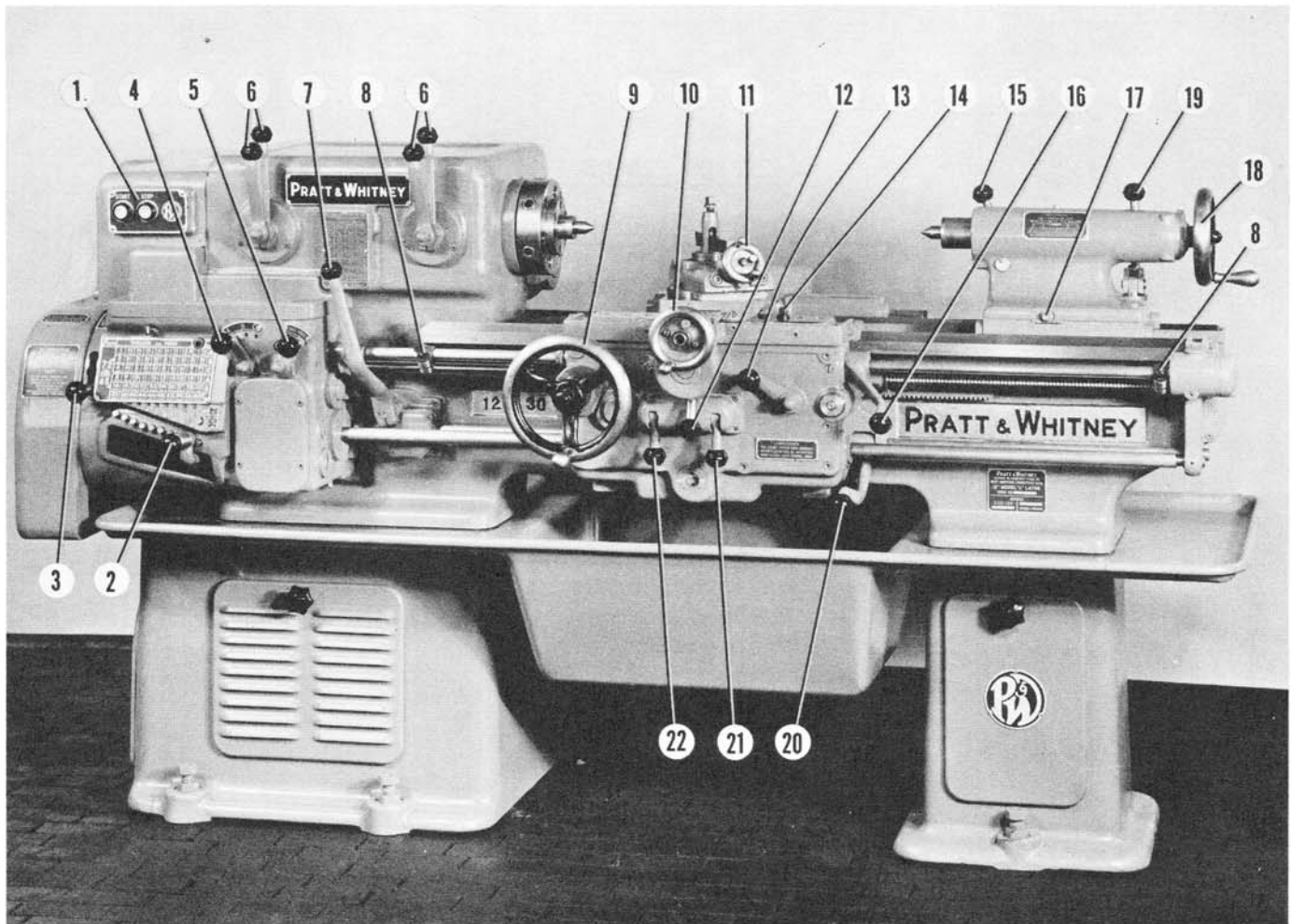

OPERATING CONTROLS

FIG. E

KEY TO FIGURE F

Miscellaneous Regular Equipment

1. Knockout rod
3. Wrench for compound rest swivel nuts
and cross slide stop rod and latch
4. Wrench for tool post screw taper bar
shoe and bracket bolts
5. T-wrench for spindle nose cam-locks
6. Dog driver plate
7. Oiler quill for tailstock center
8. Center for headstock spindle
9. Center for tailstock spindle
10. Tool post disassembled showing the washer,
rocker and screw
11. Large face plate
12. Steady rest

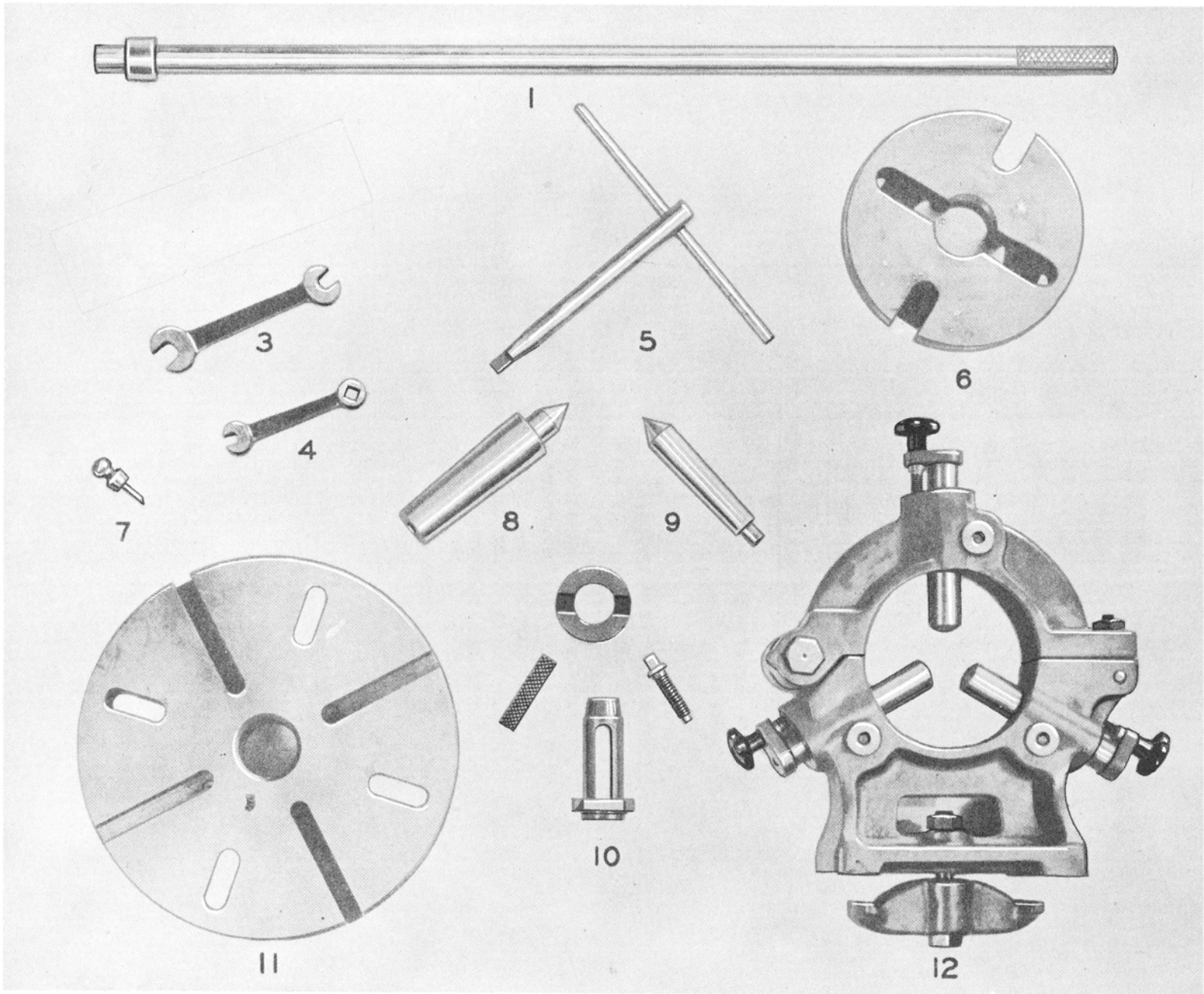

FIG. F

MISCELLANEOUS REGULAR EQUIPMENT

KEY TO FIGURE G

Additional Equipment (to order only)

- a. Expansion arbors and bushings
- b. Step chucks
- c. Follow rest
- d. Collet rack
- e. Micrometer carriage stop
- f. Taper attachment
 - 1. Taper bar scale graduated in inches per foot
 - 2. Cross slide feed screw guide lock bolt
 - 3. Taper bar scale graduated in degrees
 - 4. Taper bar bracket clamp
 - 5. Knob for setting taper bar at desired angle
 - 6. Taper bar binder
 - 7. Taper bar
 - 8. Taper bar shoe
 - 9. Taper bar bracket

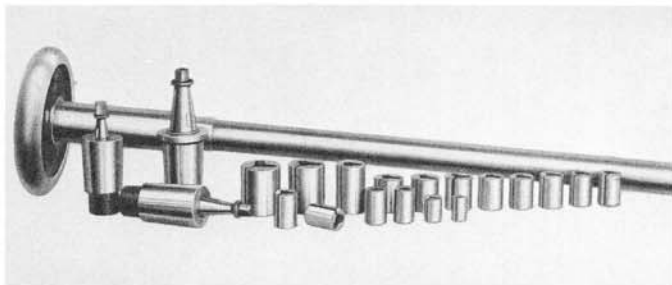

a. Expansion Arbors and Bushings

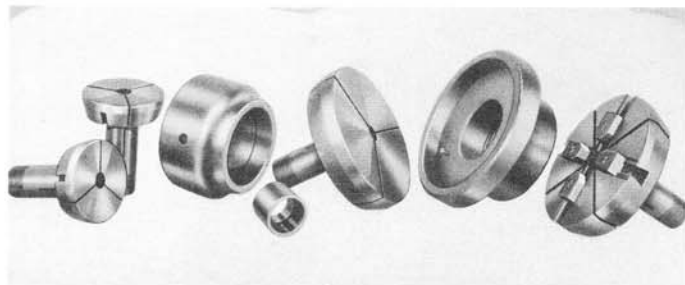

b. Step Chucks

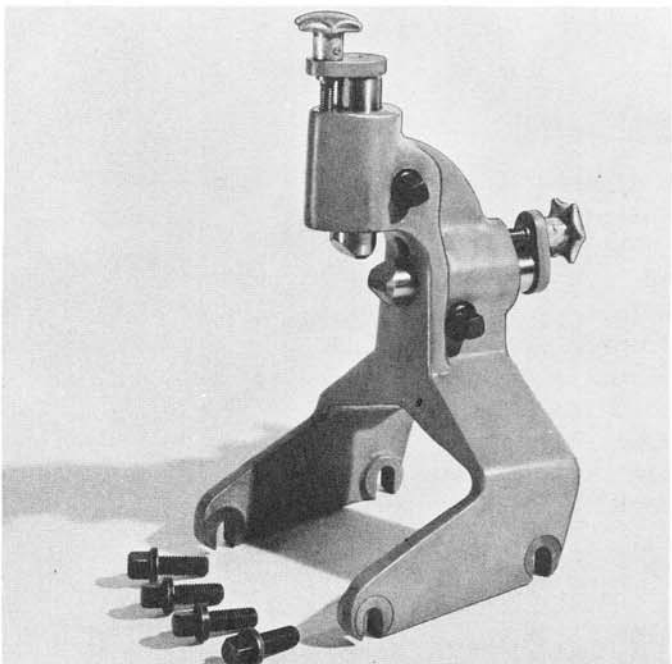

c. Follow Rest

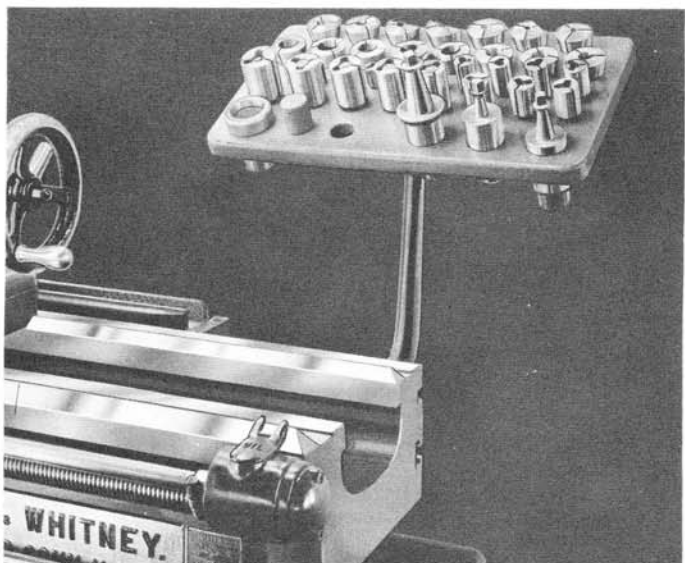

d. Collet Holder

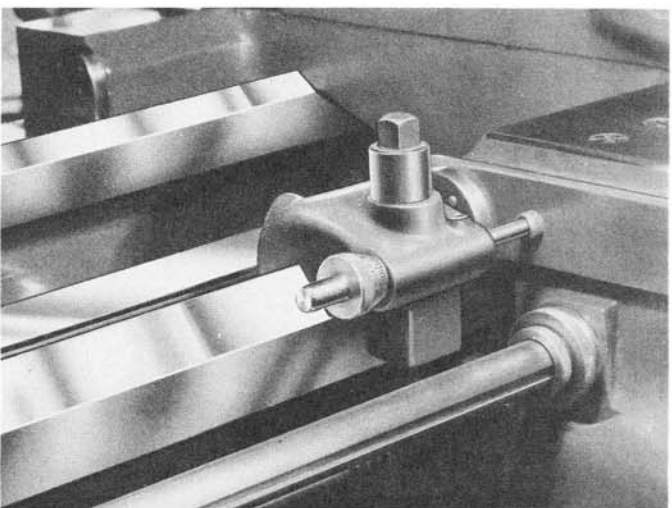

e. Micrometer Carriage Stop

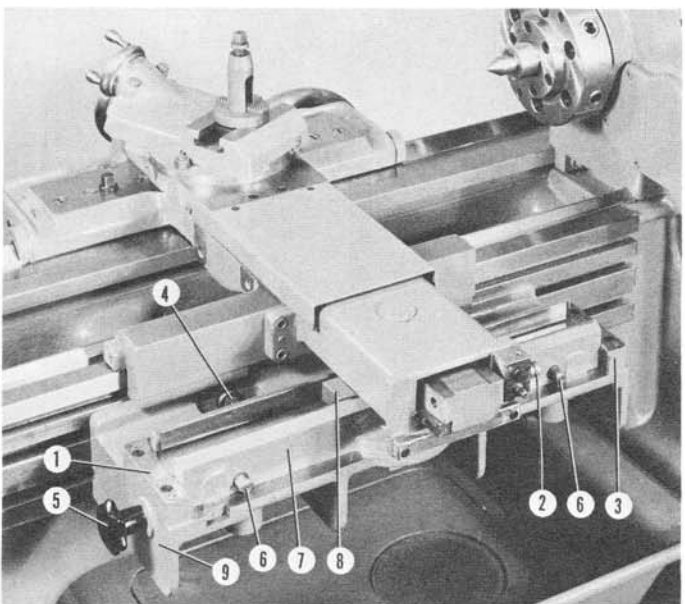

f. Taper Attachment

ADDITIONAL EQUIPMENT

KEY TO FIGURE HAdditional Equipment

- a. Multiple indexing face plate
- b. Carriage spacing attachment
 - 1. Dial indicator bracket
 - 2. Dial indicator
 - 3. Inside micrometer
 - 4. End measure trough
 - 5. Adjustable measuring contact
 - 6. Outboard support bushing
 - 7. Measuring contact binder
 - 8. Outboard support clamp bolt
 - 9. Outboard support
- c. Pump equipment
 - 10. Pump and motor
 - 11. Flexible hose
 - 12. Flexible nozzle
- d. Speed reducer
 - 13. Disc for clamping stator to bed plate
 - 14. Bed plate
 - 15. Square headed bolt and nut
 - 16. Registration lines on rotor and stator
 - 17. Hole for square headed bolt and nut
 - 18. Index zone on stator
 - 19. Rotor
 - 20. Stator
 - 21. 60-notch index plate
 - 22. Lever for locking index plate

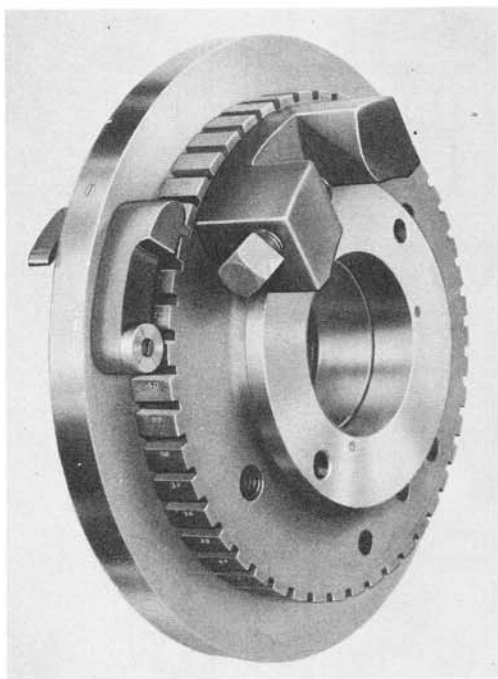

a. Multiple Indexing Face Plate

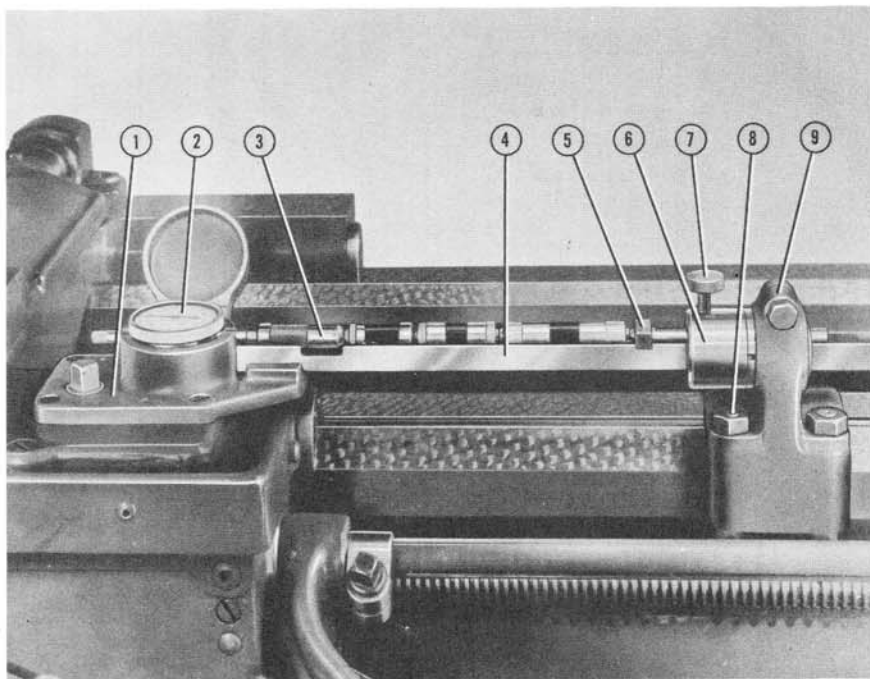

b. Carriage Spacing Attachment

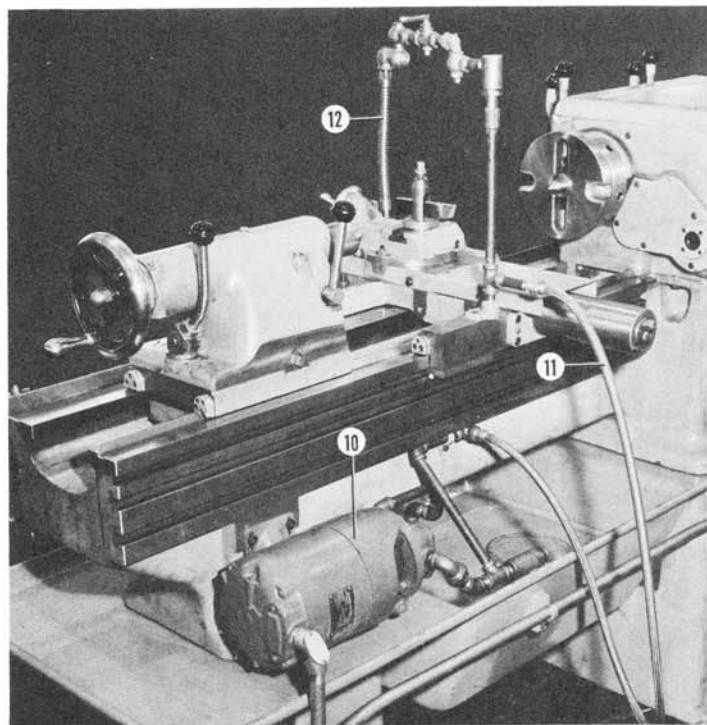

c. Pump and Piping

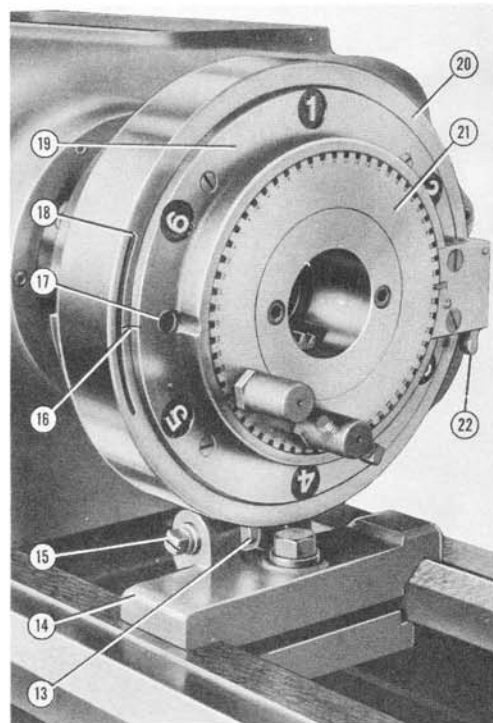

d. Speed Reducer

ADDITIONAL EQUIPMENT

FIG. H

FIG. J

DIMENSIONS SHOWN ARE APPROXIMATE

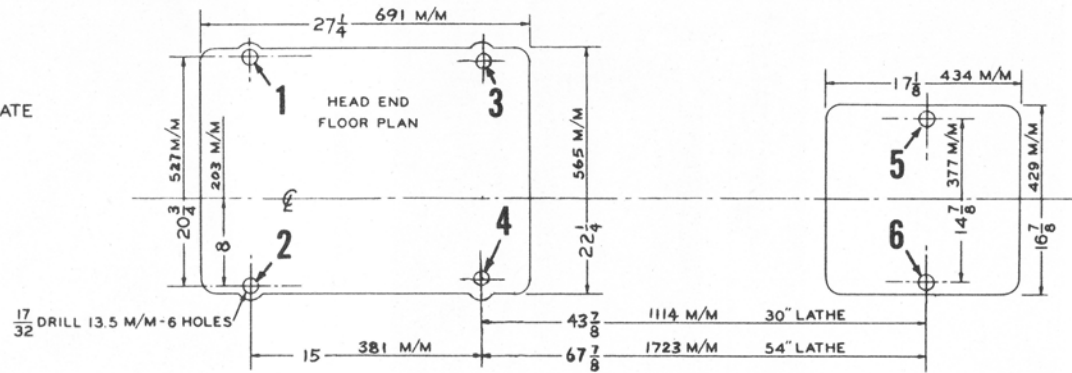

1694-R-44

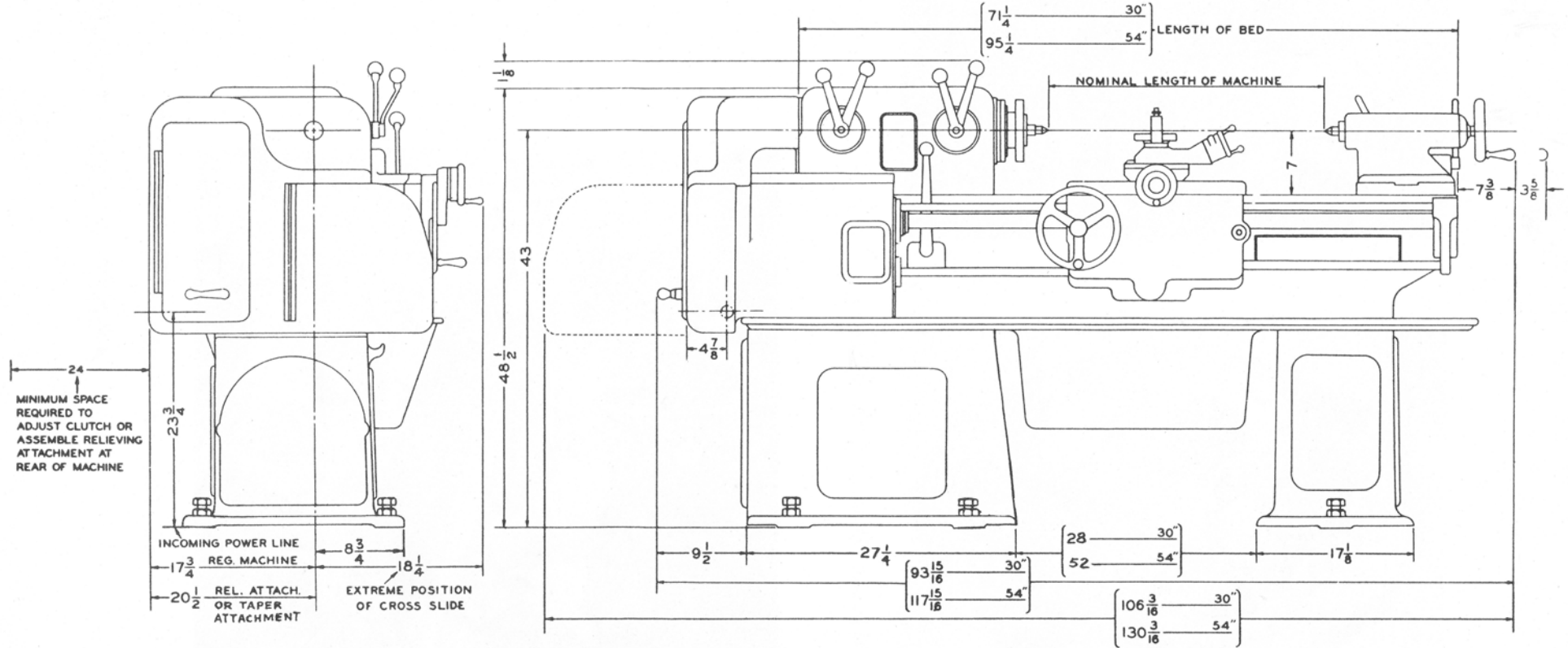

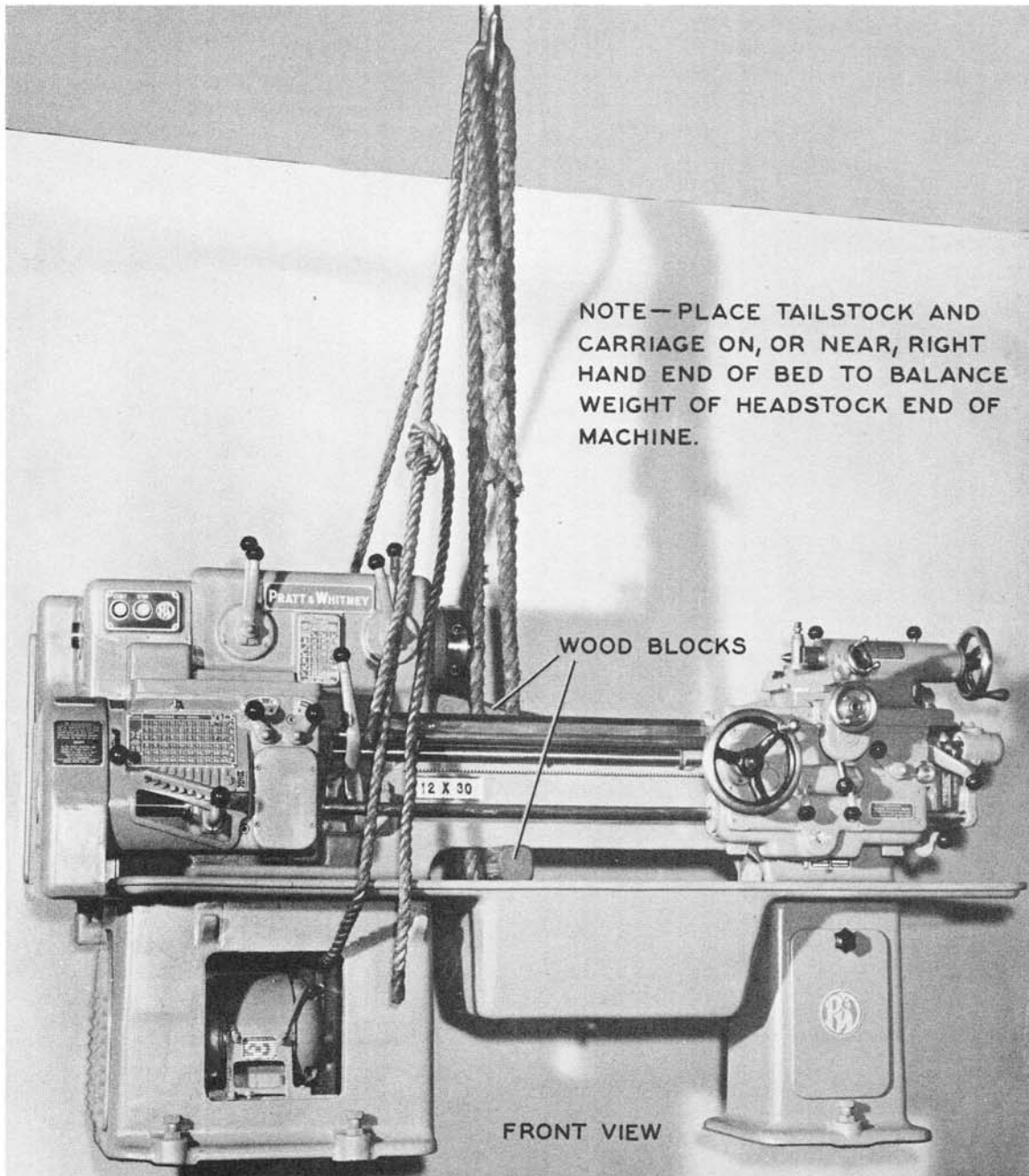
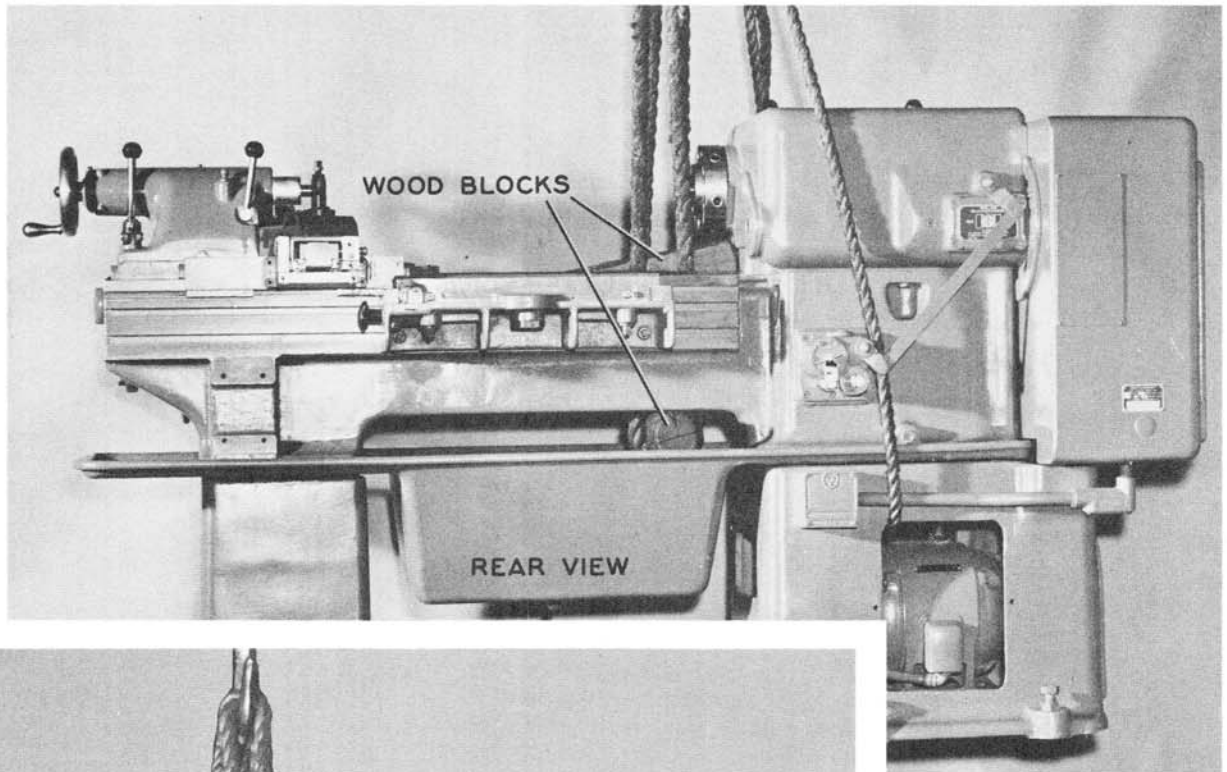

PROPER METHOD
OF LIFTING THE
LATHE

FIG. J_a

FIG. K

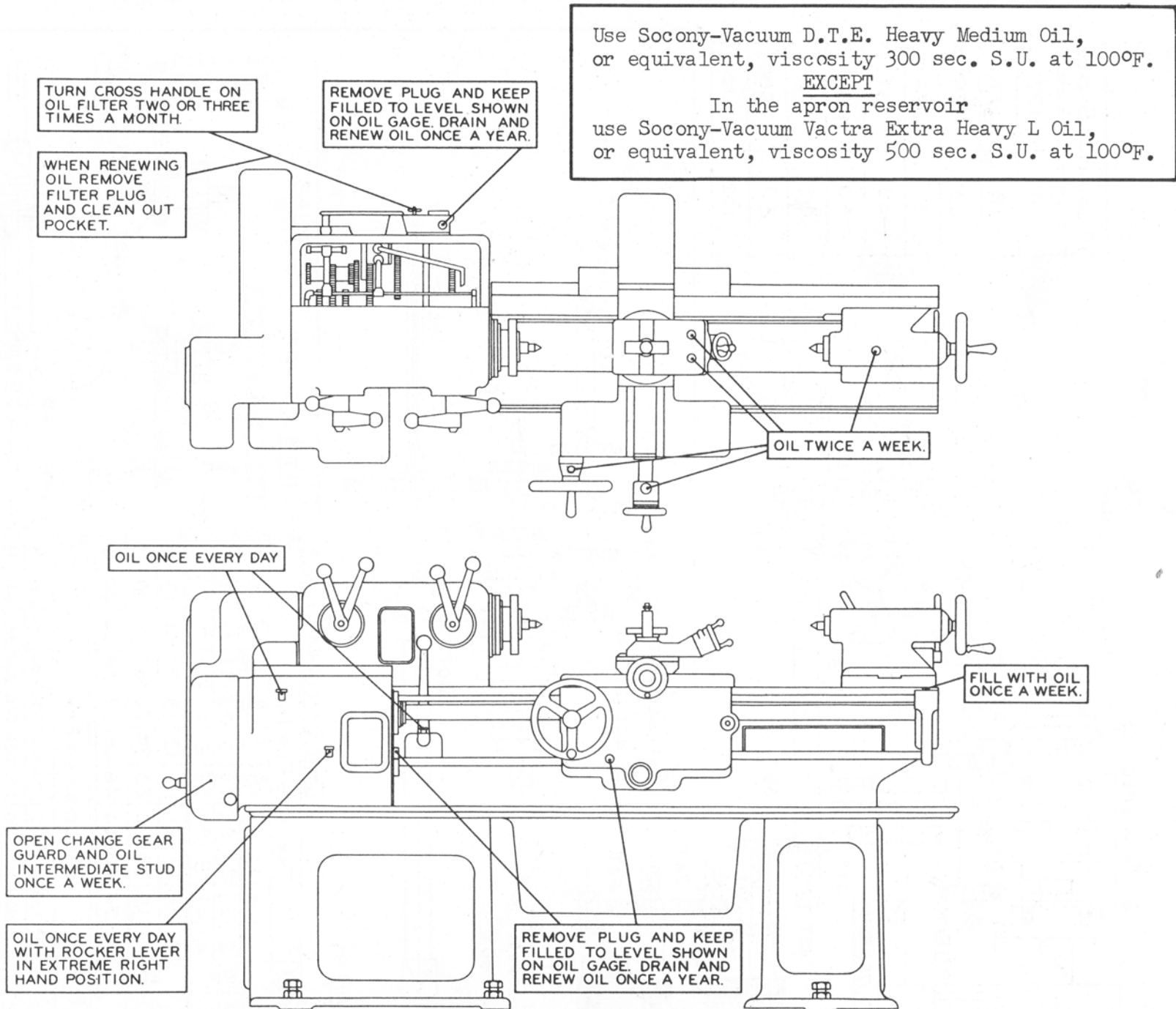

LUBRICATION CHART

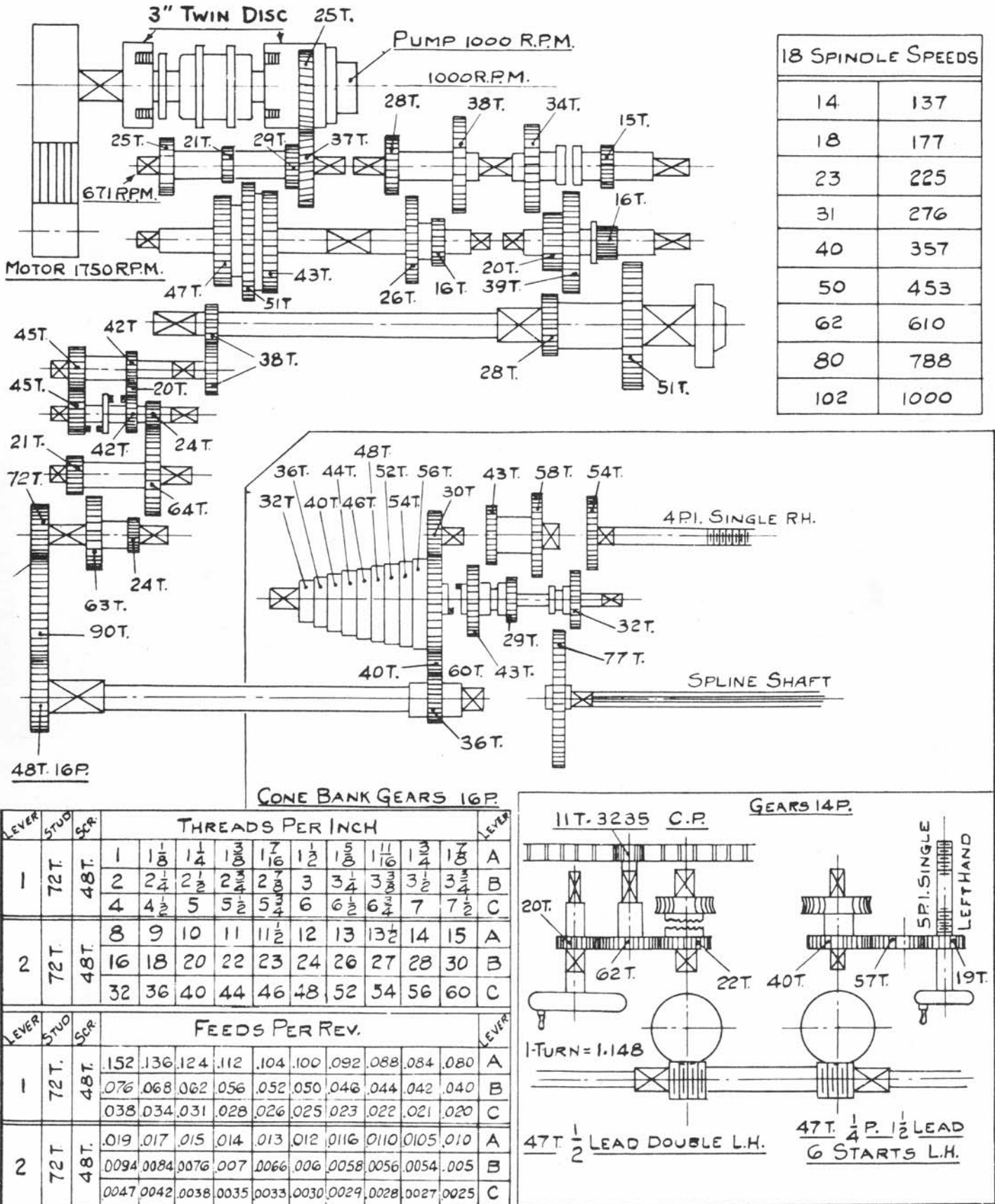

SPEED AND FEED DIAGRAM

FIG. L

CHART FOR MULTIPLE THREAD INDEXING
WITH THREAD CHASING DIAL

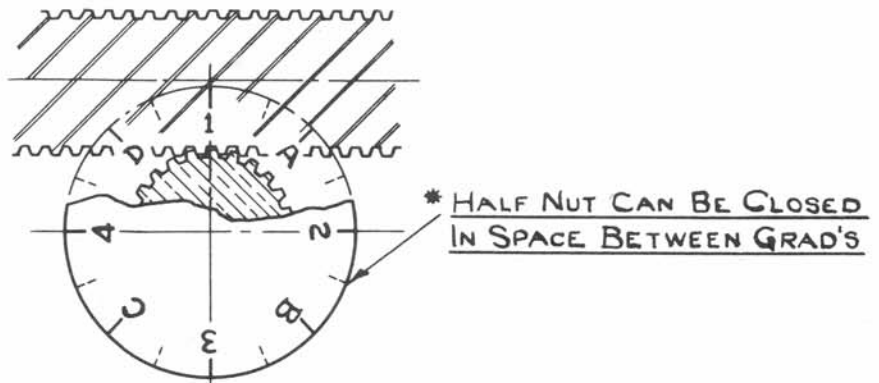

LEAD SCREW 4 P.I.-R. H. ACME
INDICATOR PINION 16 T.
1 TURN OF DIAL = 4" TRAVEL OF CARRIAGE

TO CUT MULTIPLE START THREADS :-

CLOSE HALF NUT AT NO. 1 GRADUATION AND TAKE FIRST CUT. OPEN HALF NUT AND CHANGE TO POSITIONS SHOWN IN THE TABLE BELOW FOR DIFFERENT THREADS AND STARTS.

DIAL CAN BE MADE TO TURN BY MOVING CARRIAGE WITH HANDWHEEL OR WITH CARRIAGE STATIONARY BY ALLOWING LEAD SCREW TO TURN. THE HALF NUT IS CLOSED WHEN THE PROPER GRADUATION IS IN LINE WITH REFERENCE MARK ON APRON AND THE NEXT CUT TAKEN.

SET LEVERS TO CUT	LEAD	PITCH		
		2 START	4 START	
1 $\frac{3}{4}$	$\frac{4}{7}$	3 $\frac{1}{2}$	7	<u>FOR 2 STARTS USE NO'S 1 & 3</u> <u>FOR 4 STARTS USE NO'S. 1, 2, 3 & 4</u>
2 $\frac{1}{4}$	$\frac{4}{9}$	4 $\frac{1}{2}$	9	
2 $\frac{3}{4}$	$\frac{4}{11}$	5 $\frac{1}{2}$	11	
3 $\frac{1}{4}$	$\frac{4}{13}$	6 $\frac{1}{2}$	13	
1 $\frac{1}{2}$	$\frac{2}{3}$	3	6	<u>FOR 2 STARTS USE NO'S. 1 & 2</u> <u>FOR 4 STARTS USE NO'S 1, A, 2 & B</u>
2 $\frac{1}{2}$	$\frac{2}{5}$	5	10	
3 $\frac{1}{2}$	$\frac{2}{7}$	7	14	
4 $\frac{1}{2}$	$\frac{2}{9}$	9	18	
3	$\frac{1}{3}$	6		<u>FOR 2 STARTS USE NO'S. 1 & A</u> <u>OR START AT ANY NO. AND CHANGE TO ANY LETTER.</u>
5	$\frac{1}{5}$	10		
7	$\frac{1}{7}$	14		
9	$\frac{1}{9}$	18		
11	$\frac{1}{11}$	22		
13	$\frac{1}{13}$	26		<u>FOR 2 STARTS USE ANY GRAD.</u> <u>AND CHANGE TO *SPACE BETWEEN</u>
2	$\frac{1}{2}$	4		
6	$\frac{1}{6}$	12		
10	$\frac{1}{10}$	20		
14	$\frac{1}{14}$	28		

MULTIPLE THREAD INDEXING

FIG. M

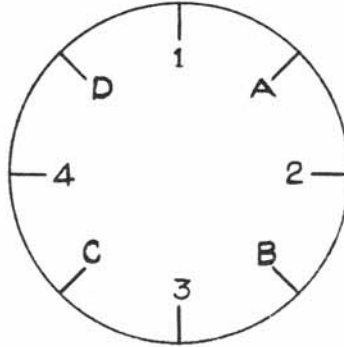

Lead Screw 4 PI R.H. Single

Indicator Pinion 16 T

1 Turn of Dial indicates 4" advance on Lead Screw.

Method of Using Dial

- For even threads that are multiples of 4
half nuts may be engaged at any point.
- For even threads that are not multiples of 4
half nuts may be engaged at any graduation.
- For odd threads
half nuts may be engaged at alternate graduations.
- For fractional threads in halves
half nuts may be engaged at opposite graduations.
- For fractional threads in quarters
use same graduation each time.
- For other fractional threads use of dial is not recommended, readings being either fractionally less or more than one full turn of dial.

THREAD CHASING DIAL - ENGLISH

FIG. N

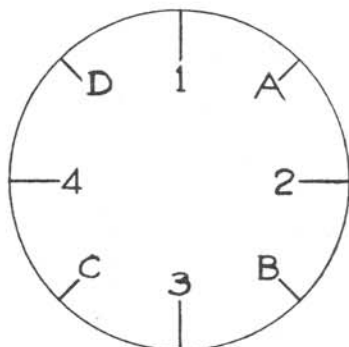

Lead Screw 1-1/4" dia., 6 M/M Lead, Single R.H.
 Indicator Pinion, 16 Teeth.
 1 Turn of Dial Indicates 96 M/M advance on Lead Screw.

For any Thread divisible into 12, Half Nut can be engaged at any graduation.

For any Thread divisible into 24, Half Nut can be engaged at any numbered graduation.

For any Thread divisible into 48, Half Nut can be engaged at any opposite graduation.

For any Thread divisible into 96, Half Nut must be engaged at same graduation each time.

For any Thread not divisible into 12-24-48-96, Thread Chasing Dial can not be used. Half Nut must be left in engagement and Apron Reverse Lever used to return Carriage to starting point of cut.

THREAD CHASING DIAL - METRIC

FIG. N_M

FORMULA FOR FIGURING CHANGE GEARS FOR SPECIAL THREADS

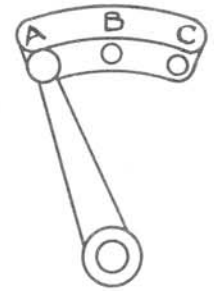
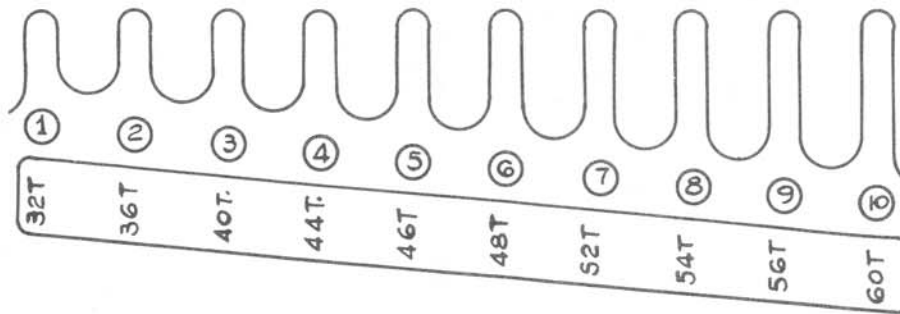

ROCKER GEAR 36T.

G = GEARS IN CONE BANK

LEAD SCREW 4 P.i.

<p><u>R = RATIO OF GEARS IN GEAR BOX</u></p> <p>UP { A 4 : 1 B 2 : 1 C 1 : 1</p> <p>DOWN { A... 1 : 2 B... 1 : 4 C... 1 : 8</p>		<p><u>RATIO OBTAINED THRU CONE BANK</u></p> $\frac{36 \times 32 \times 1}{G \times 54 \times 4} = \frac{16}{3G}$
<p>A</p> <p>FOR SIMPLE GEARING</p> $\frac{A \times 16}{B \times 3G} \times R = \text{LEAD}$ $\text{LEAD} = \frac{1}{\text{THOS. PER IN.}}$ <p>B</p>	<p>A</p> <p>FOR COMPOUND GEARING</p> $\frac{A \times C \times 16}{B \times D \times 3G} \times R = \text{LEAD}$ $\text{LEAD} = \frac{1}{\text{THOS. PER IN.}}$ <p>C</p> <p>D</p> <p>B</p>	

THE FOLLOWING METHOD CAN BE USED IN MOST CASES.

SELECT SOME CONVENIENT THREAD ON INDEX PLATE AND SET CHANGE GEAR LEVERS

AS IF CUTTING THIS THREAD. THE FORMULA WOULD THEN BE;

$$\frac{72 \times \text{THREAD ON INDEX PLATE}}{48 \times \text{THREAD TO BE CUT}} = \frac{\text{GEAR ON STUD A}}{\text{GEAR ON STUD B}}$$

FOR EXAMPLE TO CUT 50 P.I., SET LEVERS TO CUT 48 P.I. THEN $\frac{72 \times 48}{48 \times 50} = \frac{A}{B} = \frac{72}{50}$

THIS MAY BE CHECKED BY FORMULA $\frac{A \times 16}{B \times 3G} \times R = \frac{72 \times 16}{50 \times 3 \times 48} \times \frac{1}{8} = \frac{1}{50} = \text{LEAD}$

IN SOME CASES IT WILL BE FOUND NECESSARY TO USE COMPOUND GEARING,

IN WHICH CASE THE FORMULA BECOMES, $\frac{72 \times \text{THD ON INDEX PLATE}}{48 \times \text{THD. TO BE CUT}} = \frac{A \times C}{B \times D}$

CHANGE GEARS FOR SPECIAL THREADS - ENGLISH

FIG. 0

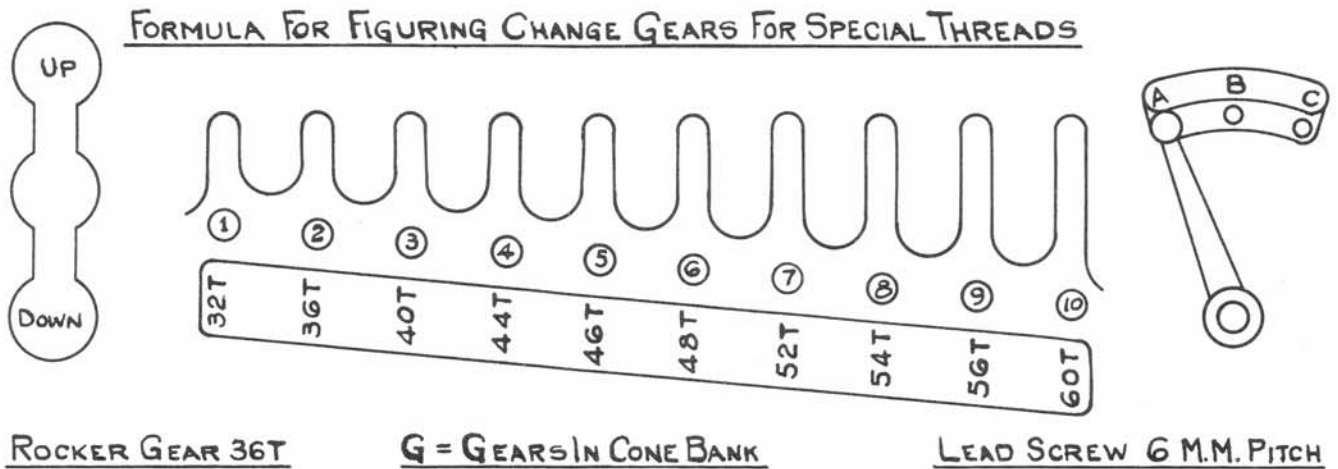

<p style="text-align: center;"><u>R = RATIO OF GEARS IN GEAR BOX</u></p> <div style="display: flex; justify-content: space-between;"> <div style="width: 45%;"> <p><u>UP</u> { A... 4 : 1 B... 2 : 1 C... 1 : 1</p> </div> <div style="width: 45%;"> <p><u>DOWN</u> { A... 1 : 2 B... 1 : 4 C... 1 : 8</p> </div> </div>	<p style="text-align: center;"><u>RATIO OBTAINED THRU CONE BANK</u></p> $\frac{36 \times 32 \times 6}{G \times 54 \times 1} = \frac{128}{G}$
<p style="text-align: center;"><u>FOR SIMPLE GEARING</u></p> $\frac{A \times 128}{B \times G} \times R = \text{LEAD IN M.M.}$	<p style="text-align: center;"><u>FOR COMPOUND GEARING</u></p> $\frac{A \times C \times 128}{B \times D \times G} \times R = \text{LEAD IN M.M.}$

THE FOLLOWING METHOD CAN BE USED IN MOST CASES.

SELECT SOME CONVENIENT THREAD ON INDEX PLATE AND SET CHANGE GEAR LEVERS

AS IF CUTTING THIS THREAD. THE FORMULA WOULD THEN BE:-

$$\frac{\text{STUD GEAR ON PLATE} \times \text{THREAD TO BE CUT}}{\text{SCREW GEAR ON PLATE} \times \text{THREAD ON INDEX PLATE}} = \frac{\text{GEAR ON STUD A}}{\text{GEAR ON STUD B}}$$

FOR EXAMPLE TO CUT 9 M.M. LEAD SET LEVERS TO CUT 12 MM LEAD THEN $\frac{45 \times 9}{48 \times 12} = \frac{A}{B} = \frac{45}{64}$

THIS MAY BE CHECKED BY FORMULA $\frac{A \times 128}{B \times G} \times R = \frac{45 \times 128}{64 \times 40} \times \frac{4}{1} = 9$

IN SOME CASES IT WILL BE FOUND NECESSARY TO USE COMPOUND GEARING, IN WHICH CASE

THE FORMULA BECOMES; $\frac{\text{STUD GEAR ON PLATE} \times \text{THREAD TO BE CUT}}{\text{SCREW GEAR ON PLATE} \times \text{THREAD ON INDEX PLATE}} = \frac{A \times C}{B \times D}$

CHANGE GEARS FOR SPECIAL THREADS - METRIC

FIG. OM

THREADS PER CENTIMETER

LEAD SCREW 6 M/M

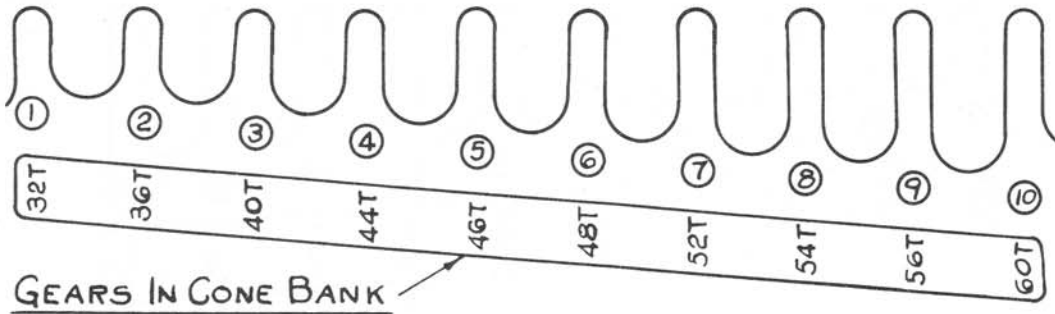

ROCKER GEAR = 36T



THREADS PER CENTIMETER	STUD	SCREW	RATIO LEVER	ROCKER LEV. ON PIN	CHANGE LEVER
2	60	48	UP	1	C
3	60	48	"	6	C
4	75	64	"	10	C
5	72	72	DOWN	1	A
6	60	72	"	1	A
7	50	70	"	1	A
8	45	72	"	1	A
9	60	72	"	6	A
10	72	72	"	1	B
11	50	55	"	1	B
12	60	72	"	1	B
13	60	78	"	1	B
14	50	70	"	1	B
15	48	72	"	1	B
16	45	72	"	1	B
17	40	68	"	1	B
18	60	72	"	6	B
19	45	57	"	6	B
20	72	72	"	1	C
21	60	63	"	1	C
22	60	66	"	1	C
23	60	69	"	1	C
24	60	72	"	1	C
25	48	60	"	1	C

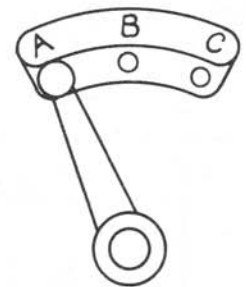

CHANGE LEVER

RATIO LEVER

UP = $\frac{1}{1}$ RATIO

DOWN = $\frac{1}{8}$ RATIO

A = $\frac{4}{1}$ RATIO

B = $\frac{2}{1}$ RATIO

C = $\frac{1}{1}$ RATIO

METRIC THREAD CHART

FIG. P_M



GEARS	DIAMETRICAL PITCHES										LEVER
71 <hr/> STUD	4	4½	5	5½	5¾	6	6½	6¾	7	7½	A
	8	9	10	11	11½	12	13	13½	14	15	B
	16	18	20	22	23	24	26	27	28	30	C
SCREW <hr/> 56	32	36	40	44	46	48	52	54	56	60	A
	64	72	80	88	92	96	104	108	112	120	B
	128	144	160	176	184	192	208	216	224	240	C

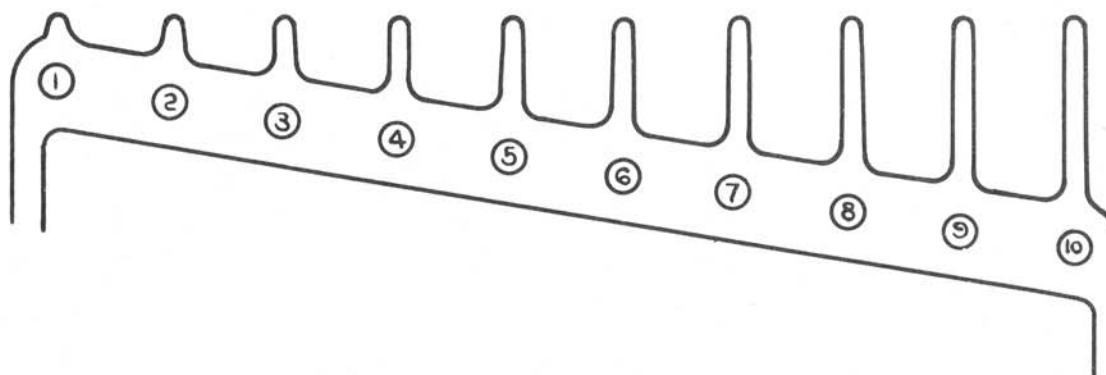
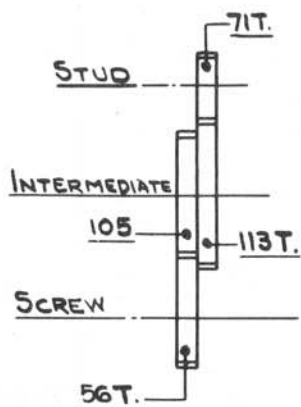

FIG. Q

INDEX TO DIAMETRICAL PITCHES

SPEED REDUCER THREAD INDEX

RATIO LEVER	STUD.	INTER.	SCREW	THREADS PER INCH										LEVER
				1	1 ¹ / ₈	1 ¹ / ₄	1 ³ / ₈	7 ¹ / ₁₆	1 ¹ / ₂	1 ⁵ / ₈	1 ¹¹ / ₁₆	1 ³ / ₄	1 ⁷ / ₈	
UPPER HOLE	48	90	48	1	1 ¹ / ₈	1 ¹ / ₄	1 ³ / ₈	7 ¹ / ₁₆	1 ¹ / ₂	1 ⁵ / ₈	1 ¹¹ / ₁₆	1 ³ / ₄	1 ⁷ / ₈	C
LOWER HOLE	"	"	"	2	2 ¹ / ₄	2 ¹ / ₂	2 ³ / ₄	2 ⁷ / ₈	3	3 ¹ / ₄	3 ³ / ₈	3 ¹ / ₂	3 ³ / ₄	A
	"	"	"	4	4 ¹ / ₂	5	5 ¹ / ₂	5 ³ / ₄	6	6 ¹ / ₂	6 ³ / ₄	7	7 ¹ / ₂	B
1:8	"	"	"	8	9	10	11	11 ¹ / ₂	12	13	13 ¹ / ₂	14	15	C
LEADS IN INCHES														
UPPER HOLE 1:1	72	90	36	8	7.1111	6.40	5.8181	5.565	5.333	4.9230	4.7407	4.5714	4.2666	A
	54	"	"	6	5.333	4.80	4.363	4.173	4.00	3.692	3.555	3.428	3.2	A
	72	"	"	4	3.555	3.2	2.909	2.782	2.666	2.461	2.370	2.285	2.1333	B
	54	"	"	3	2.666	2.40	2.1817	2.086	2.00	1.846	1.7777	1.7142	1.6	B
	72	"	"	2	1.7777	1.600	1.4545	1.3913	1.3333	1.2305	1.1850	1.1428	1.0666	C
	54	"	"	1.5	1.3333	1.200	1.0908	1.043	1.000	.923	.8888	.8571	.8	C
LOWER HOLE 1:8	72	"	"	1	.8888	.800	.7272	.6956	.6666	.6153	.5925	.5714	.5333	A
	54	"	"	.75	.6666	.600	.5456	.5215	.50	.4615	.4444	.4285	.4	A
	72	"	"	.50	.4444	.400	.3636	.3478	.3333	.3076	.2962	.2857	.2666	B
	54	"	"	.375	.3333	.300	.273	.2607	.250	.2307	.2222	.2142	.2	B
	72	"	"	.250	.2222	.200	.1818	.1739	.1666	.1538	.1481	.1428	.1333	C
	54	"	"	.1875	.1666	.1500	.1363	.1304	.1250	.1153	.1111	.1071	.1000	C

R = RATIO OF GEARS IN GEAR BOX
 A = GEAR ON STUD
 B = GEAR ON SCREW
 G = GEAR ON CONE BANK
 L = LEAD TO BE CUT
 RATIOS OBTAINED THRU GEAR BOX AND RATIO LEVERS ARE AS FOLLOWS

RATIO LEVER	GEAR BOX LEVER	RATIO-R
UP	A	4 : 1
	B	2 : 1
	C	1 : 1
DOWN	A	1 : 2
	B	1 : 4
	C	1 : 8

RATIO OBTAINED THRU CONE BANK

$$\frac{36}{G} \times \frac{32}{54} = \frac{64}{3G}$$

FORMULA

$$\frac{6}{T} \times R \times \frac{64}{3G} \times \frac{1}{4} \times \frac{A}{B} = L \text{ OR } \frac{G}{R} \times \frac{L}{32} = \frac{A}{B}$$

NOTE: WHEN LEADS OTHER THAN THOSE LISTED ABOVE ARE WANTED, USE FORMULA BELOW FOR PROPER GEARS

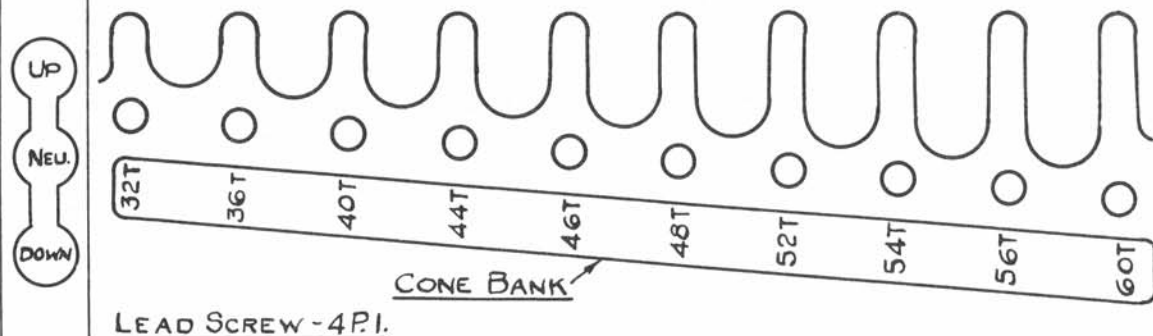

1 REV. OF FACE PLATE = 6 REV. OF SPINDLE

EXAMPLE
LEAD TO CUT 2.5

SELECT FIGURE IN LEAD TABLE NEAR 2.5
 FIND RATIO "R" FROM RATIO POSITIONS INDICATED
 AND CONE BANK GEAR "G" BELOW. IF GEARS ARE
 NOT SUITABLE TRY OTHERS NEAR FIGURES.

SOLUTION

$$\frac{32}{2} \times \frac{2.5}{32} = \frac{A}{B} = \frac{5}{4} \text{ OR } \frac{45 \text{ STUD}}{36 \text{ SCREW}}$$

LEADS AND THREADS WITH SPEED REDUCER

ENGLISH TO METRIC TRANSPOSITION

STUD SCREW		LEAD IN MILLIMETERS								LEVER	
63	48	21.		16.8			14.		12.	11.2	A
45	"	15.		12.			10.			8.	
65	40	13.		10.4				8.			B
66	48	11.		8.8	8.						
63	"	10.5		8.4			7.		6.	5.6	C
45	"	7.5		6.			5.			4.	
65	40	6.5		5.2				4.			C
66	48	5.5		4.4	4.						
63	"	5.25		4.2			3.5		3.	2.8	C
45	"	3.75		3.			2.5			2.	
65	40	3.25		2.6				2.			A
66	48	2.75		2.2	2.						
63	"			2.1			1.75		1.5	1.4	A
45	"			1.5			1.25			1.0	
66	48			1.1	1.						B
63	"			1.05					0.75	0.7	
51	"			0.85							C
66	48			0.55	0.5						



METRIC INDEX
PLATE

STUD

SECTOR

SCREW

A.P.I. ENGLISH
SCREW

FIGURES SHOWN CORRESPOND WITH THOSE ON C-157

32 36 40 44 46 48 52 54 56 60

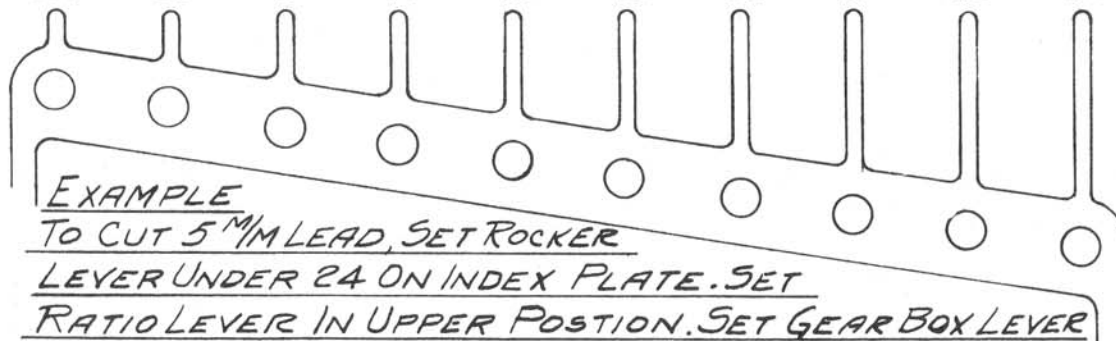

EXAMPLE

TO CUT 5 MM LEAD, SET ROCKER

LEVER UNDER 24 ON INDEX PLATE. SET

RATIO LEVER IN UPPER POSITION. SET GEAR BOX LEVER

AGAINST POSITION B. GEAR ON STUD 45, GEAR ON SCREW 48

ENGLISH TO METRIC TRANSPOSITION

FIG. 5M

FIG. TM

METRIC TO ENGLISH TRANSPOSITION

GEARS	THREADS PER INCH										LEVER
72 STUD = SCREW 48	1	1 ¹ / ₈	1 ¹ / ₄	1 ³ / ₈	1 ⁷ / ₁₆	1 ¹ / ₂	1 ⁵ / ₈	1 ¹¹ / ₁₆	1 ³ / ₄	1 ⁷ / ₈	A
	2	2 ¹ / ₄	2 ¹ / ₂	2 ³ / ₄	2 ⁷ / ₈	3	3 ¹ / ₄	3 ³ / ₈	3 ¹ / ₂	3 ³ / ₄	B
	4	4 ¹ / ₂	5	5 ¹ / ₂	5 ³ / ₄	6	6 ¹ / ₂	6 ³ / ₄	7	7 ¹ / ₂	C
	8	9	10	11	11 ¹ / ₂	12	13	13 ¹ / ₂	14	15	A
	16	18	20	22	23	24	26	27	28	30	B
	32	36	40	44	46	48	52	54	56	60	C

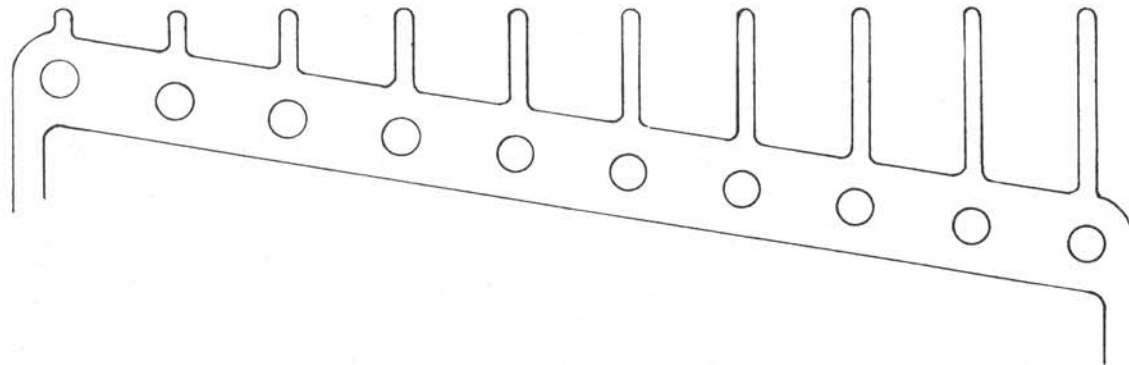
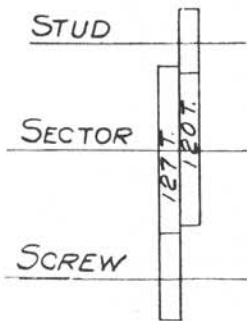

METRIC TO ENGLISH TRANSPOSITION

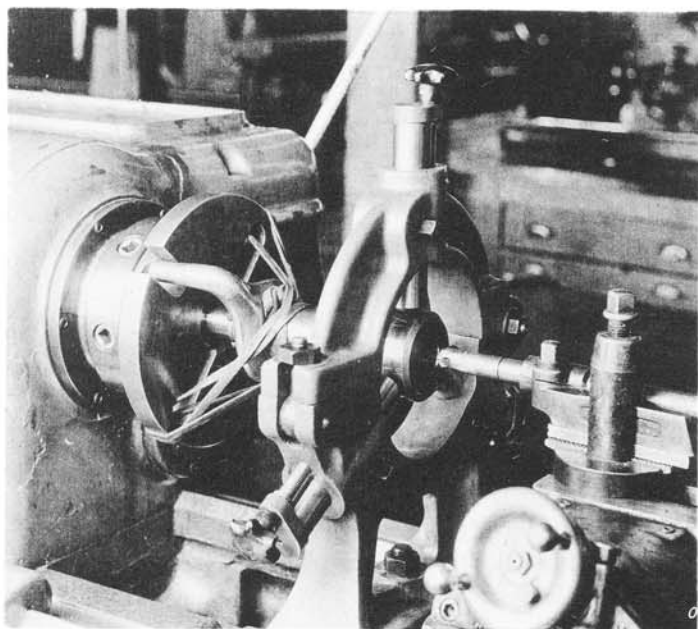

A

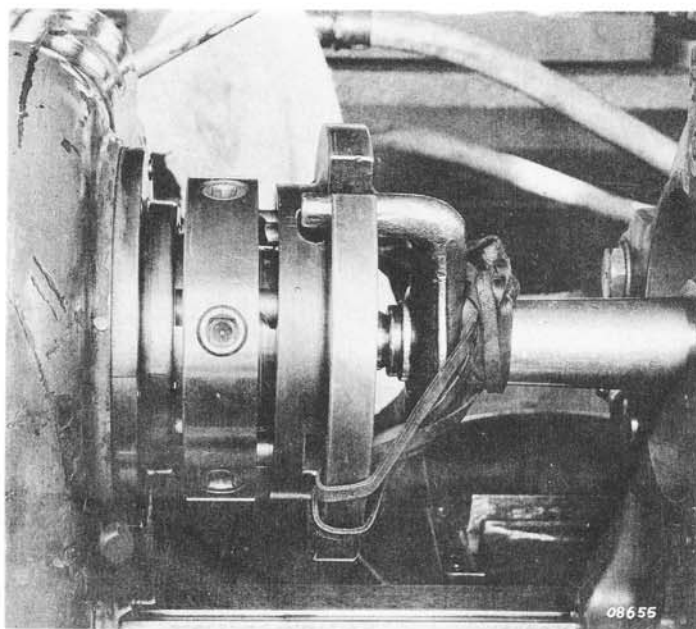

B

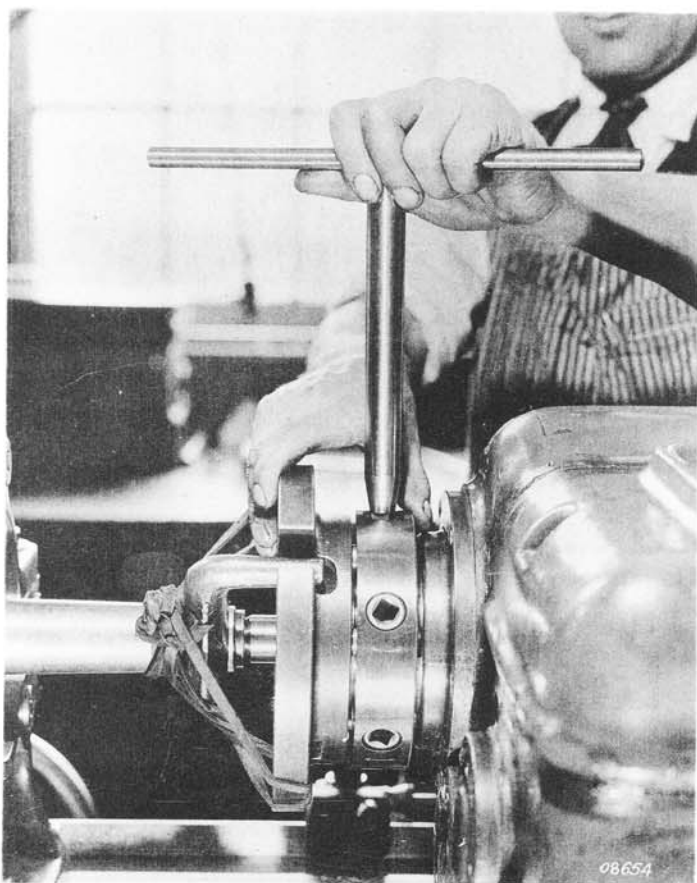

C



D

STRAPPING WORK TO THE DOG DRIVER PLATE

A detailed description will be found on the next page.

FIG. U

STRAPPING WORK TO THE DOG DRIVER PLATE

When drilling or boring a hole in the center of a piece of work, and on other occasions, it is often necessary to hold one end of the work on the headstock center and the other end in a steady rest. As the tailstock cannot be used for supporting the work, there is a tendency for it to slide backward and slip off the headstock center. To prevent this, the work can be tied to the dog driver plate.

Although a steel strap and bolts are often used for this purpose, it has been found that a leather thong is very satisfactory for odd jobs of this kind. Illustration U-a shows the work in position for boring.

The dog driver plates furnished with Pratt & Whitney Model "C" Lathes have been provided with two opposite openings near the periphery for entering the thong. Tie the work to the dog driver plate leaving the face of the plate about $1/4$ " to $1/2$ " away from the spindle flange for draw as shown in U-b.

To bring the cam-locks into engagement, pull the dog driver plate up by hand, as shown in U-c, or by entering a rod between the tool post and the plate, using the carriage to push the plate up to about $1/8$ " from the flange of the spindle as shown in U-d. The final drawing up of the plate and tightening of the thong is done with the cam-lock wrench.

To remove the work, unlock the cam-locks of the dog driver plate before untying the thong.



*"There Is No Better Paying Investment Than
The Right Tools For The Job"*