



# **OPERATOR'S MANUAL**

**MODEL HLV-H  
HARDINGE HIGH SPEED PRECISION  
TOOL ROOM LATHE**

**READ INSTRUCTIONS CAREFULLY**

**BEFORE USING MACHINE**

When this instruction book was printed the information given was up-to-date. However, Hardinge is constantly improving the design of their machine tools and it is possible that the illustrations and descriptions may vary somewhat from the machine you received. This merely implies that the machine you received is the latest improved model to better fulfill your requirements.

**HARDINGE BROTHERS, INC.**

**ELMIRA, NEW YORK**



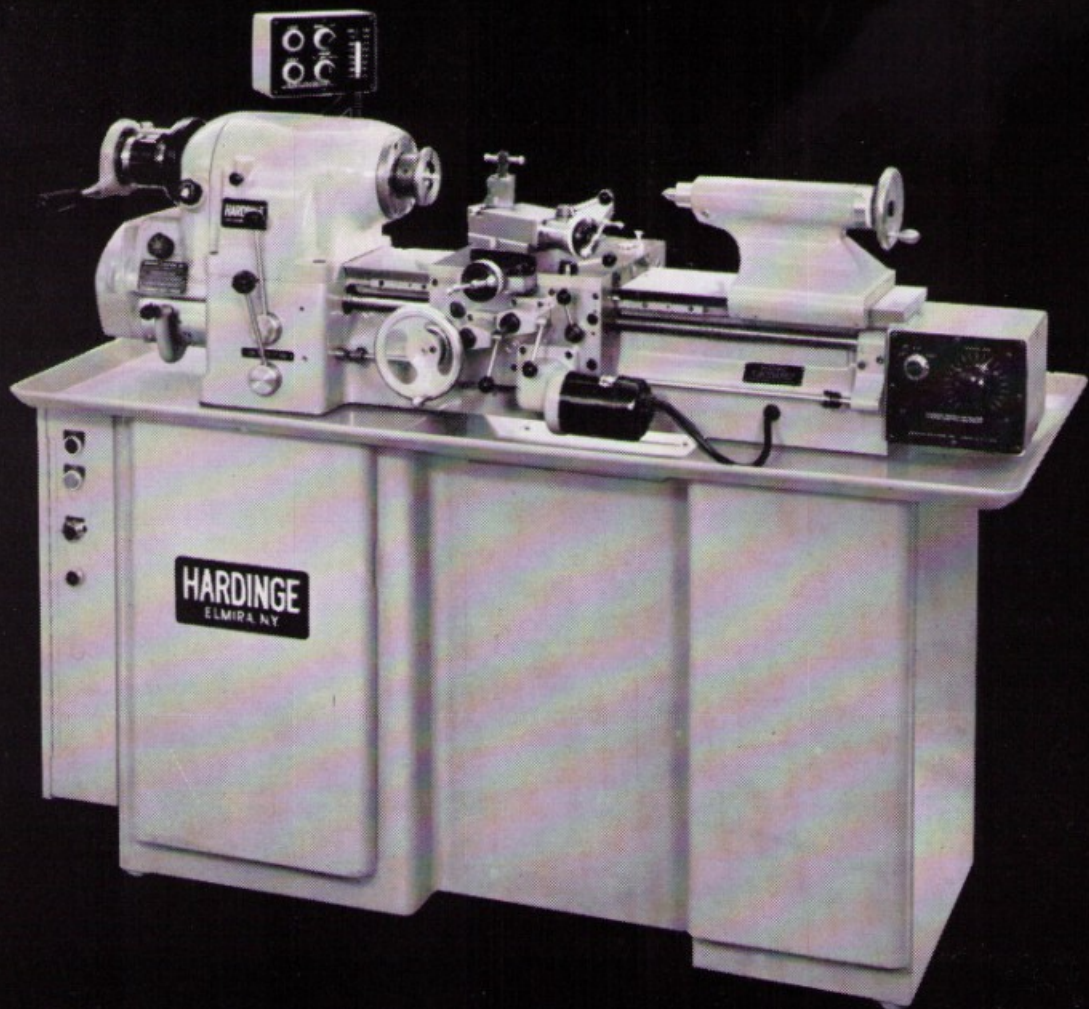

MODEL HLV-H  
HARDINGE HIGH SPEED TOOL ROOM LATHE

with

**HARDINGE**

**DOVETAIL BED**

SOLID HARDENED AND GROUND STEEL

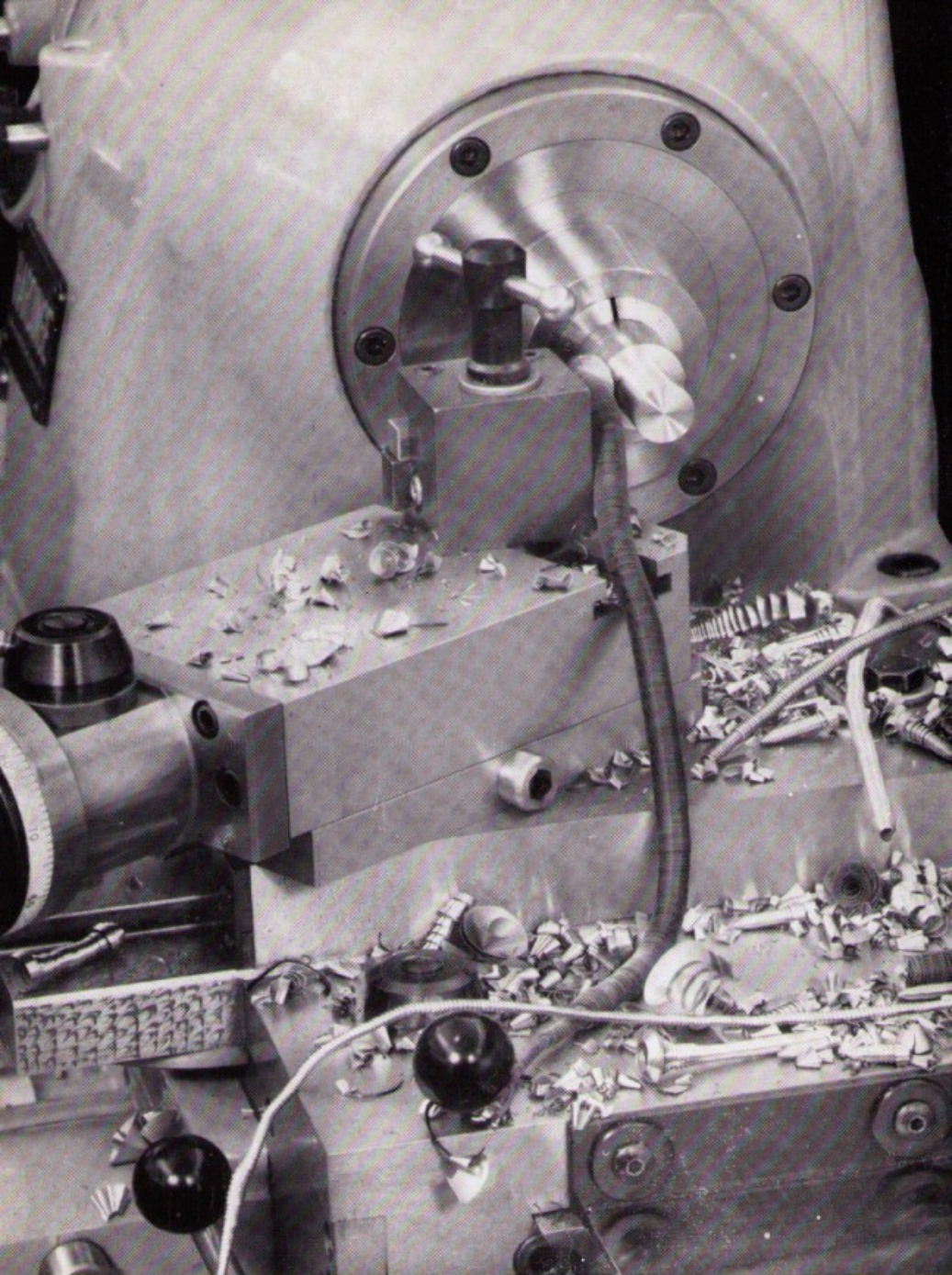

An example of modern turning with work held in a collet. With the Hardinge HLV-H Lathe the collets seat directly in the spindle for maximum accuracy and rigidity. For fast, accurate, easy chucking, use collets to hold your work — available in round, hexagon and square fractional sizes from collet stocks in Elmira, New York, and sixteen principal cities.



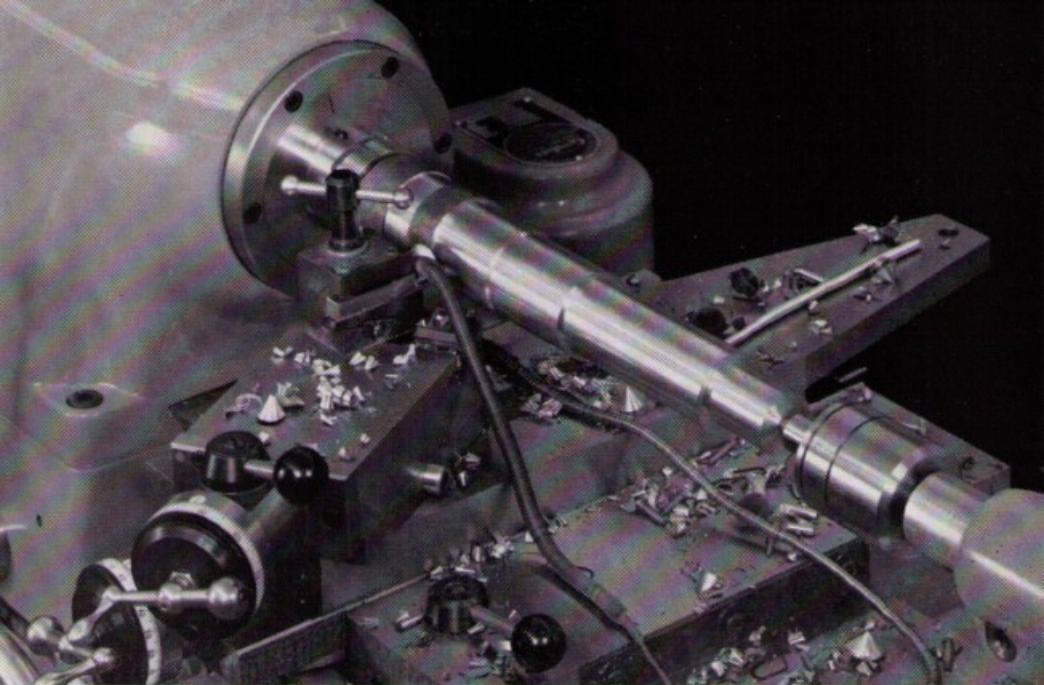

The setup illustrated above is given to show the range of the Hardinge HLV-H Lathe. Compare it to the illustration on Page 4.

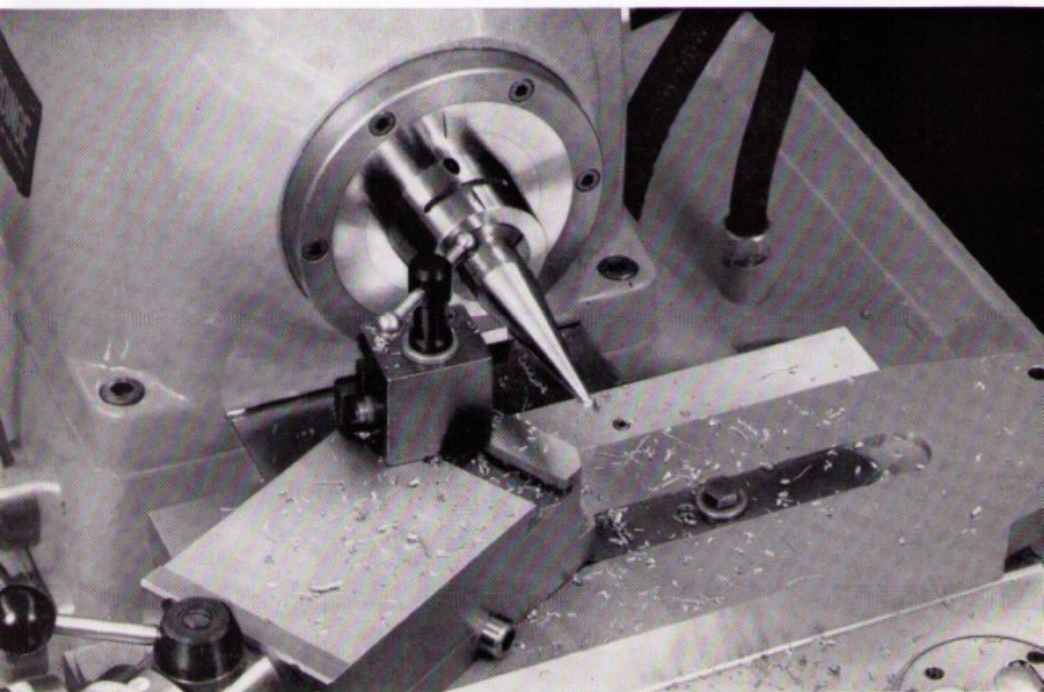

Precision taper turning is easy when done on the Hardinge HLV-H Lathe equipped with a taper turning attachment.



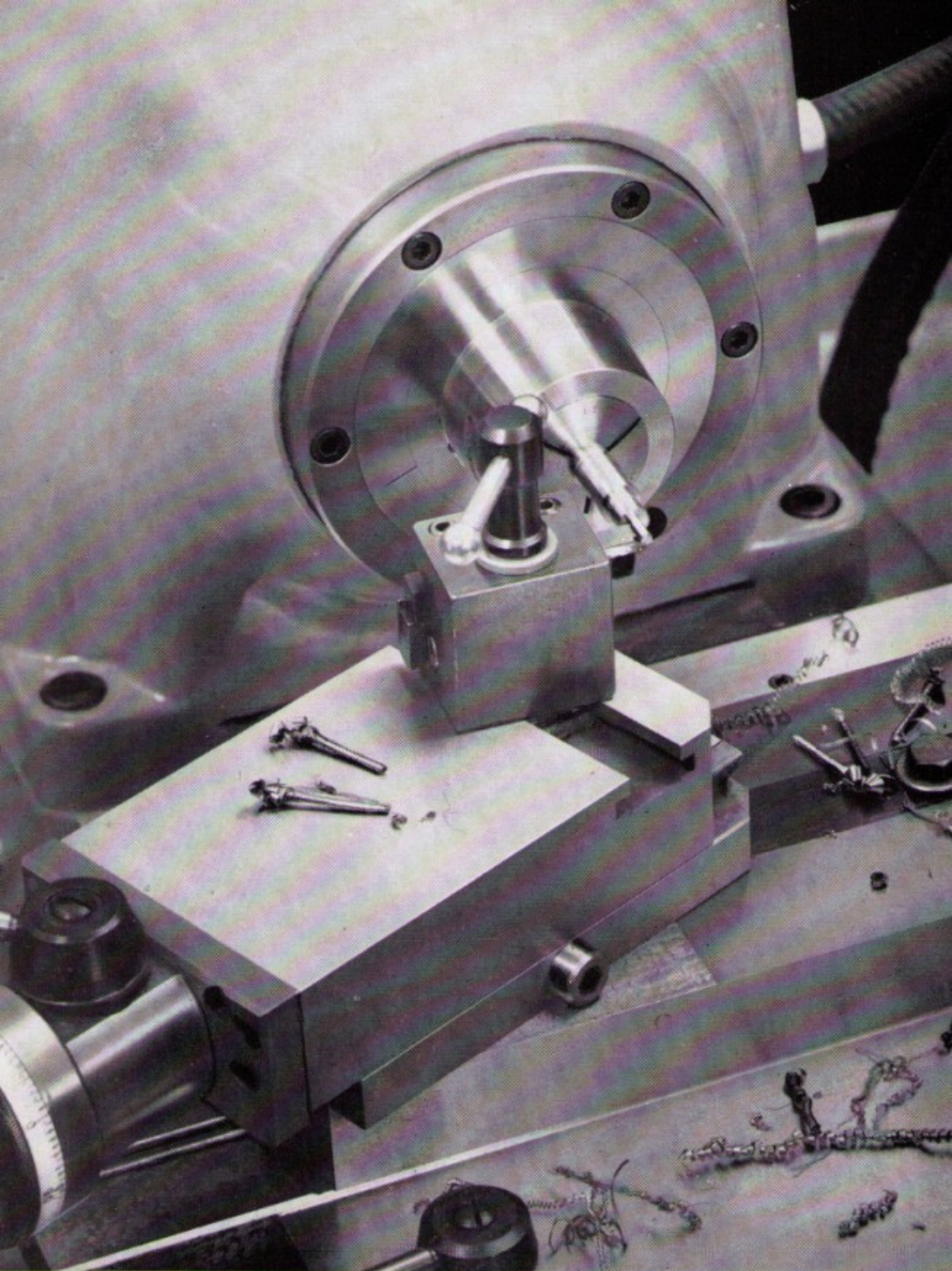

The smooth, powerful endless V-belt drive of the Hardinge HLV-H Lathe, coupled with the high speeds obtained, make small diameter work easy and efficient.



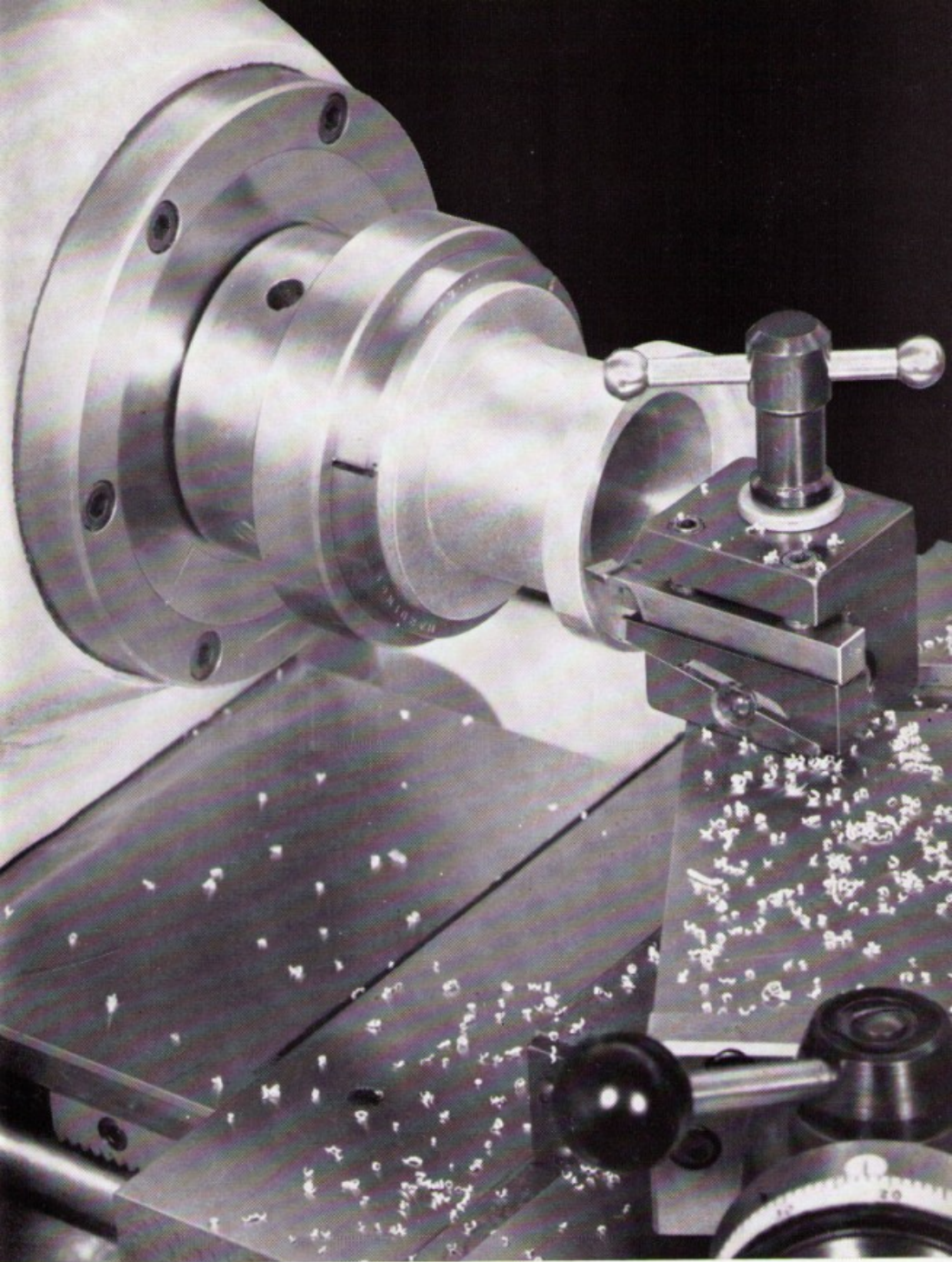

An example of proper holding of an instrument part for accurate, high speed machining by holding the part in a standard step chuck. See Pages 50, 51, 52 and 53 for full information on step chucks and closers.



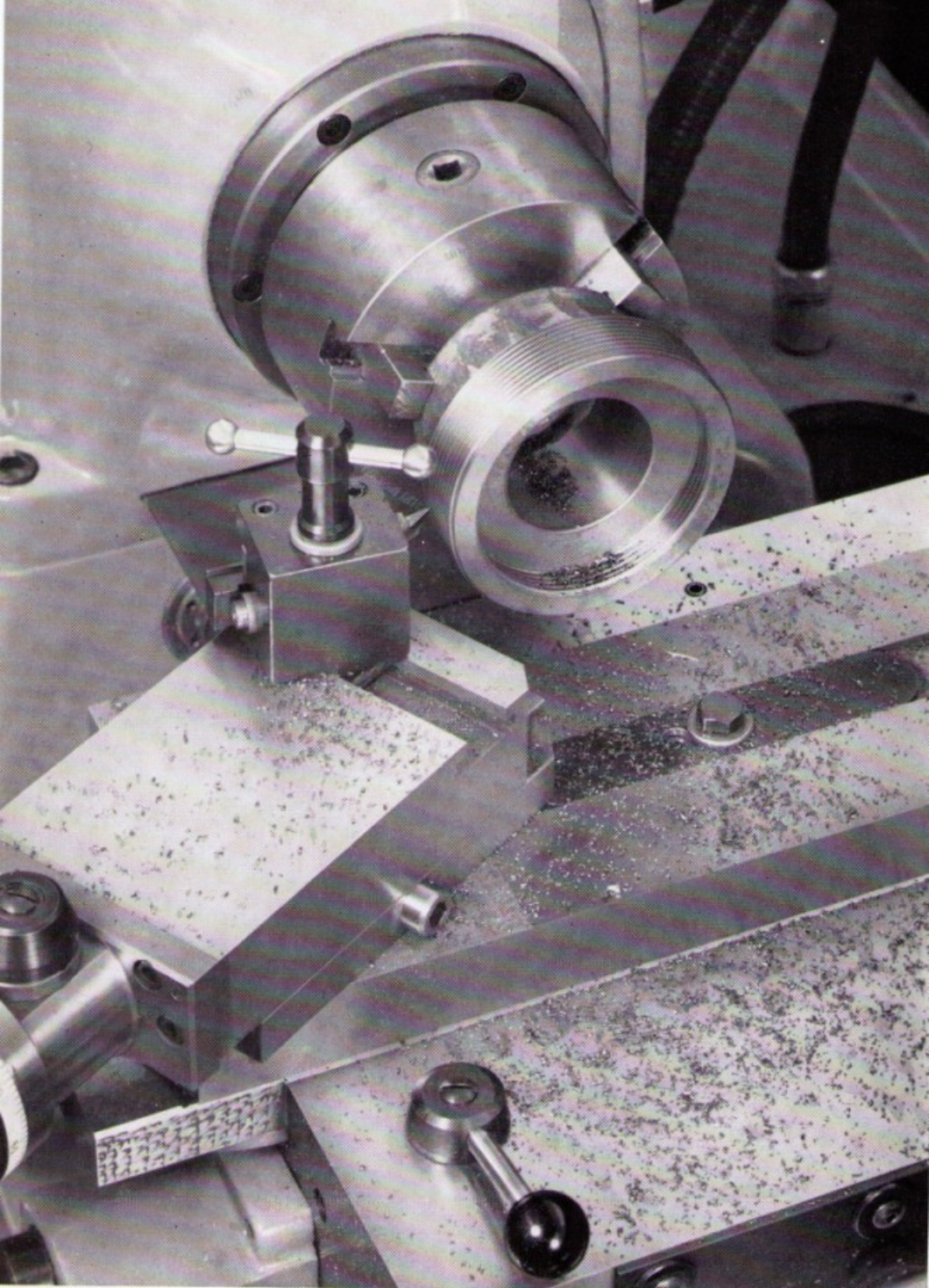

The setup illustrated above shows the use of a three jaw chuck to hold a forged steel part. Jaw chucks are shown on Page 48.



# CONTENTS

	PAGE
BELTS — Headstock Belt Removal .....	18
Motor Belt Adjustment .....	15
Motor Belt Removal .....	18
CARRIAGE — Clutch Adjustment .....	26
Handwheel .....	24
Lead Screw Nut .....	25
Lock .....	25
Power Feed .....	29
Tool Post Slide .....	24
COLLET CLOSER — Adjustment .....	22
Applying .....	23
Removal .....	23
CONTROL LEVERS .....	12
CONTROL PANEL .....	14
COOLANT FACILITIES .....	66
CROSS SLIDE — Backlash Adjustment .....	28
Handle .....	24
Lock .....	27
Removal .....	28
ELECTRICAL CONNECTIONS .....	10
FLOOR PLAN .....	44
GIB ADJUSTMENT — Carriage .....	28
Cross Slide .....	28
Compound Slide .....	28
LUBRICATION — Bedway .....	27
Carriage and Apron .....	25
Change Gears .....	33
Driveshaft and Bearings .....	16
Headstock Bearings .....	21
Variable Speed Pulleys .....	14
Variable Speed Vertical Screw .....	9
MACHINE — Cleaning .....	9
Foundation .....	8
Installation .....	8
Leveling .....	9
Lifting .....	8
Regular Equipment .....	45
Specifications .....	45
SPINDLE — Apply Tooling .....	20
Collet Key .....	21
Driveshaft Brake .....	16
Driving Unit .....	14
Free Spindle .....	13
Lock Pin .....	12
Start and Stop .....	13
TAILSTOCK .....	43
THREADING — Gear Box .....	30
Gear Chart (English) .....	34
Gear Chart (Metric) .....	64
Gearbox Disconnect .....	12
Instructions .....	38
Outside Change Gears .....	33
Three Change Knob .....	31
Tumbler Handle .....	32
TOOLING — Bed .....	59 & 60
Carriage .....	54 thru 58
Headstock .....	46 thru 53
Holders .....	67
Tailstock .....	61 thru 63

## INSTALLATION INSTRUCTIONS

Remove crating, but do not remove machine from skid. Move machine to the location in your plant where it is to be used and then remove machine from skid. See instructions below for lifting machine from skid.

**LIFTING MACHINE.** Remove the four bolts which hold the machine to the shipping skids. There are two bolts at the extreme left-hand end of the pedestal and two at right-hand end.

The machine may be removed from the skid by either a crane or fork lift truck. Lifting with a crane, the rope or cable sling should be arranged as shown on this page. **NEVER LIFT MACHINE WITH ROPE OR CABLE AROUND SPINDLE, BED OR TAILSTOCK.**

The rope or cable must be capable of withstanding a weight of 2000 pounds. When using a lift truck, adjust forks to go in between top planks of skid and bottom of pedestal base. Lift machine slowly, checking to see that the correct balance is obtained. Use caution, as machine has somewhat more weight at the front and it is more easily tipped using the lift truck method than the crane and sling method.

After skid has been removed place machine directly on location where it is to be used.

**MACHINE FOUNDATION.** The Hardinge HLV-H Precision Lathe is designed to operate without the need of special foundations. A substantial wood or concrete floor is satisfactory. It must, however, be fairly flat and have sufficient strength to support machine properly.

Do not locate machine near other equipment that causes vibration which will transmit to this machine, as poor work finish will result.

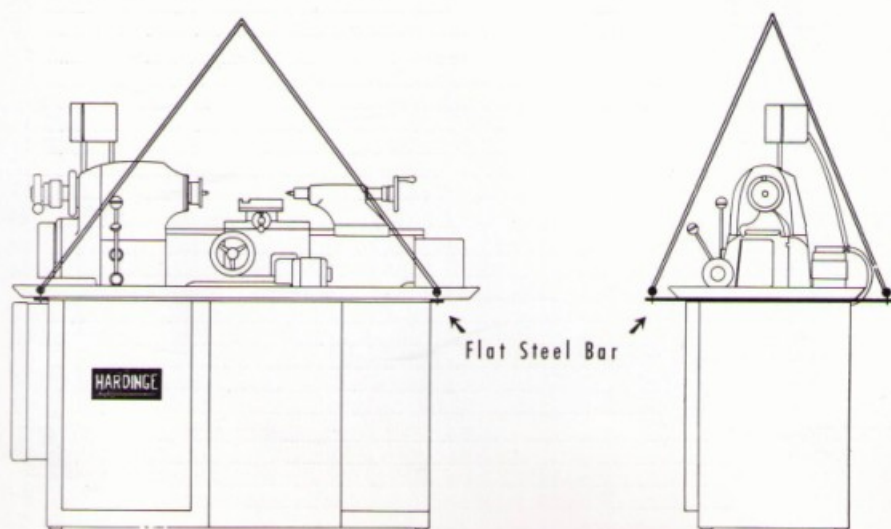



## INSTALLATION INSTRUCTIONS (Continued)

**LEVELING MACHINE.** The Hardinge HLV-H Precision Lathe is designed with a three point bearing arrangement between bed and pedestal base. The three point bearing arrangement makes accurate leveling unnecessary. Leveling should be such as to be reasonable and so that coolant will properly drain back into sump from ends of pan.

There is an adjustable foot at back right-hand corner of the pedestal base to compensate for uneven floor conditions. To adjust, loosen the socket set screw and raise or lower the foot with a pin wrench so that all four feet rest firmly on the floor. Tighten socket set screw to retain setting. Should floor conditions be such that adjustable foot does not take care of the leveling, use shims under feet of pedestal.

**CLEANING MACHINE.** Use a cloth or brush to clean this precision machine. **DO NOT CLEAN MACHINE WITH COMPRESSED AIR.** The use of compressed air for cleaning a machine reduces the precision life of the machine. Small particles of dirt and foreign matter can be forced past seals and wipers into the precision slides and bearings. **USE ONLY CLOTH OR BRUSH TO CLEAN MACHINE.** This also applies to daily cleaning of unit after it is in operation.

After machine has been properly located, leveled and bolted to floor, clean off all anti-rust shipping grease and dirt accumulated in transit with a good grade of grease solvent. Remove wood shipping retainer block and wire binding from variable speed countershaft pulley assembly. Using a  $\frac{3}{4}$ " socket wrench remove and discard shipping hold down clamps located up inside motor compartment over the top of the pulley assembly.

Remove all shipping grease from variable speed vertical screw "A", Figure 1, pulleys and brake drum, with cloth dampened with solvent. **Do not saturate belts with solvent.** Lubricate nut at grease fitting "B" and oil vertical screw with light oil for first "run-in" only. Keep vertical screw lubricated by greasing at fitting "B" using a good grade of grease such as Houghton absorbed oil #L-4 $\frac{1}{2}$ . LUBRICATE ONCE A MONTH or oftener if necessary. Add a few drops of light oil to brake drum "C". Clean motor compartment and tool storage compartment. Put bottom tool shelf in place.

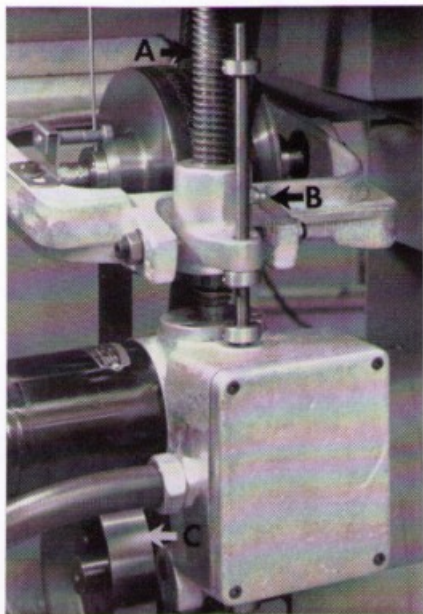

Figure 1

## ELECTRICAL CONNECTIONS

The machine is shipped completely wired and assembled. It is only necessary to run the electric power line to the top of the control panel, Figure 2, and attach the wires to the three terminals in the panel shown at "A", Figure 2. Electric power feed for carriage is connected to main control panel and does not require a separate power line. **BEFORE CHECKING ROTATION APPLY COLLET, WITH STOCK IN PLACE, TO HEADSTOCK SPINDLE AND TIGHTEN.** Also check that collet closer latch "A", Figure 11, Page 22, is in closed position and spindle lock "D", Figure 3, Page 12, is in "out" or released position.

Make sure switch "B", Figure 5, Page 14 is set at **FORWARD**. **JOG SPINDLE SLIGHTLY USING LEVER "A",** Figure 3, Page 12. The spindle should rotate counterclockwise or forward when viewed from tailstock end of machine.

Figure 2

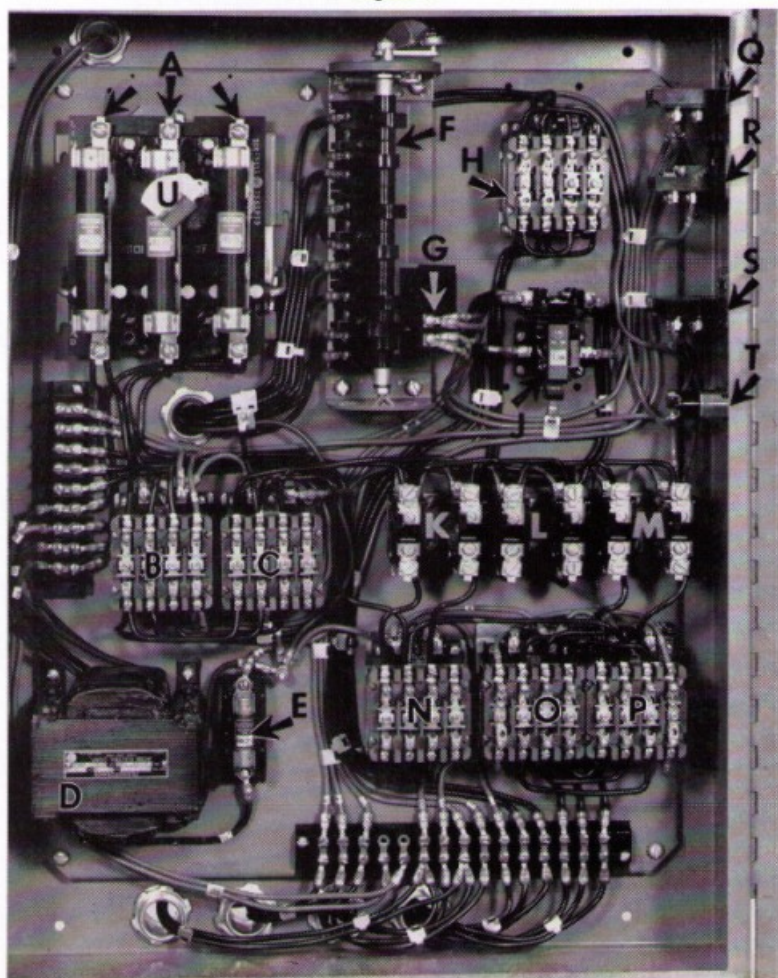



## ELECTRICAL CONNECTIONS (Continued)

If rotation is not correct, disconnect power and reverse any two of the incoming wires which connect at points "A", Figure 2. If the power should be connected incorrectly and the speed changing mechanism operated, the drive will run all the way to the top or bottom and trip a safety limit switch. To back the drive off the safety limit switch, push "STOP" button "C", Figure 5, Page 14. Turn the variable speed operating screw "A", Figure 1, Page 9, by hand three full turns to raise or lower driving unit off the safety limit switch.

Switch "A", Figure 4, Page 13, is brake release switch. During normal operation of the machine, keep set at "BRAKE" position and the brake will go "ON" and "OFF" automatically when starting or stopping machine with control lever "A", Figure 3, Page 12.

Coolant pump switch "B", Figure 4, Page 13, should be set at "OFF" unless using coolant supply. When coolant pump switch "B" is set to "ON" position, coolant pump will run continuously. If pump switch is set at the "AUTO" position coolant will flow only when machine is running.

### — SEE FIGURE 2 —

Contactor "B" is main line contactor and provides low voltage protection.

Contactor "C" is safety interlock for spindle stop pin.

Transformer "D" supplies 110 volts at control buttons "A" and "C" shown in Figure 5, Page 14.

Fuse-tron "E" provides overload protection for carriage power feed motor and secondary protection for transformer.

Main control switch "F" operates main drive motor and gives selection of **ON-OFF — HIGH-LOW** and **BRAKE**.

Switch "G" is safety interlock and cuts off power feeds when machine spindle is stopped.

Contactor "H", Figure 2, is **FORWARD-REVERSE** of main drive motor.

Contactor "J" controls brake.

Thermal overload protectors "K" are for coolant pump motor.

Thermal overload protectors "L" are for main drive motor.

Thermal overload protectors "M" are for speed change motor.

Contactor "N" controls coolant pump.

Contactor "O" controls variable speed motor for going "FASTER".

Contactor "P" controls variable speed motor for going "SLOWER".

Connection at "Q" is for the "START" button — at "R" the "STOP" button — at "S" the "REVERSE" switch and at "T" the pilot light.

Disconnect switch "U" is operated by lever "D", Figure 5, Page 14 and must be returned to "OFF" position to open switch panel.

## OPERATING INSTRUCTIONS

### SPINDLE CONTROL LEVER — Figure 3

**CONTROL LEVER "A"**, Figure 3, is the main control lever for the spindle. When moved to the extreme left the brake is released and the main drive motor is on the "LOW" side. When moved to the extreme right the brake is released and the main motor is on the "HIGH" side. The center or "STOP" position stops the motor and applies the brake.

### Direction Control Lever For Carriage — Figure 3

Control lever "B", Figure 3, reverses direction of carriage for threading only. Always place this lever in center position before starting machine.

SEE PAGE 30 FOR COMPLETE INSTRUCTIONS ON THREADING

### Disconnect For Gearbox — Figure 3

Knob "C" is used to connect or disconnect the gearbox from the headstock spindle by means of a sliding gear. **ALWAYS SHUT OFF MACHINE BEFORE ENGAGING OR DISENGAGING.** Turn knob clockwise to "FEED" position to disconnect gearbox. See Page 30 for instructions on positioning for threading.

### Spindle Lock Pin — Figure 3

The spindle lock pin "D", Figure 3 is located at the front of the headstock. The pin is held in the "OUT" or released position by a spring and ball plunger. The spindle lock pin is used to hold the headstock spindle stationary when applying or removing spindle nose attachments, adjusting collet closer, tightening draw spindle or when applying and removing work from fixtures. To engage lock pin turn spindle by hand and hold lock pin "in" until it engages in one of the notches of the spindle assembly. **RELEASE BRAKE** by setting switch "A", Figure 4, Page 13, to "OFF" position. The spindle lock pin is interlocked electrically with the main drive motor and must be withdrawn before machine will start.



Figure 3



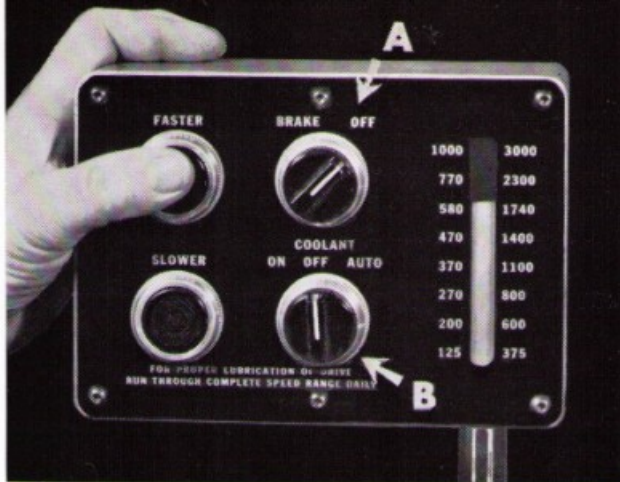

Figure 4

### To Turn Spindle By Hand

**FREE SPINDLE.** To obtain a "free spindle" for easy turning of the spindle by hand, place operating lever "A", Figure 3, in "STOP" position and turn brake switch "A", Figure 4, to "OFF" position.

### To Start and Stop Spindle — Figure 3

Pull out spindle lock pin "D", Figure 3, Page 12. Lever "A" and lever "B", Figure 3, must be in center position. Place knob "C", in "FEED" position. Set switch "B", Figure 5, Page 14, at "FORWARD". Put collet in spindle with correct size stock in place or use headstock center and tighten with collet closer. Press "START" button "A" on front of control panel, Figure 5, Page 14, which energizes panel and is indicated by pilot light "E", Figure 5, Page 14. The machine is now ready to start. Use main control lever "A", Figure 3, to start and stop the spindle. Move to extreme left to start spindle on "LOW" side of motor. Move to extreme right to start spindle on "HIGH" side of motor. Center position shuts off the main motor and applies the brake.

To make the spindle go "FASTER" push the top button as shown in Figure 4, above, until the speed indicator shows desired speed and then remove finger from button. To make spindle go "SLOWER" push lower button as shown in Figure 4, above.

The speed indicator moves up or down to indicate in the left column speed figures for the "LOW" side of the motor and in the right column for the "HIGH" side of the motor.

### Control Panel — Figure 5

"START" button "A", Figure 5, controls main contactor to energize switch control panel. **BEFORE PUSHING "START"** button see instructions on Page 13, to **"START AND STOP SPINDLE"**. Push **"STOP"** button "C" when finished using lathe.

Switch "B", Figure 5, is **FORWARD-REVERSE** for spindle.

Switch "A", Figure 4, releases brake when set at **"OFF"** to give "free spindle".

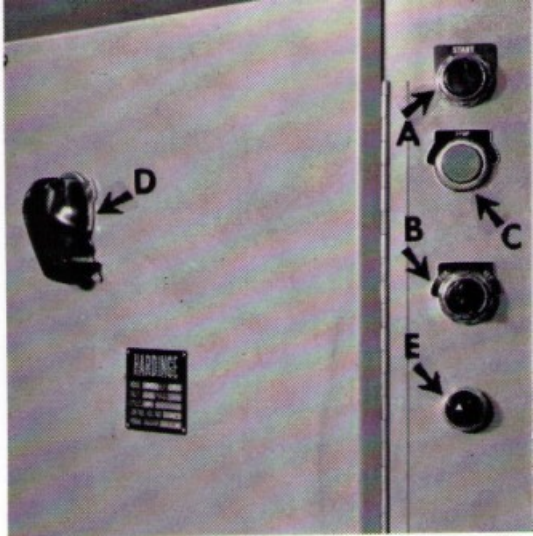

Figure 5

When set at **"BRAKE"** the brake automatically goes **"ON"** or **"OFF"** when using control lever "A", Figure 3, Page 12. Coolant switch "B", Figure 4, Page 13, should be at **"OFF"** unless using coolant supply.

### Spindle Driving Unit — Figure 6

The driving unit provides infinitely variable spindle speeds from 125 to 3000 R.P.M. by push button control as illustrated on Page 13. Speed changes can be made while the tool is actually "under cut" with the operator watching the chip and tool to obtain fastest chip removal and longest tool life.

Push button controlled motor "A", Figure 6, is a reversing motor and actuates speed changing screw "B" which in turn raises or lowers frame "C". Frame "C" carries the countershaft pulley assembly "D".

### Countershaft Pulley Assembly — Figure 6

The entire countershaft pulley assembly including the shaft "F", Figure 6, is free to float from side to side. The center sheave of the assembly is independent of the two outer sections which are in a fixed position on the shaft.

The pulley frame "C", Figure 6, is hinged at point "E" and when the front end is raised or lowered, belt tension will move the center sheave sideways and change the ratio between the driven and the driving pulley which changes the headstock spindle speed.

The variable speed pulleys have a built-in lubricating system. Run the machine, each day, through a complete cycle from 125 to 3000 R.P.M. to lubricate the pulleys and keep them operating efficiently.



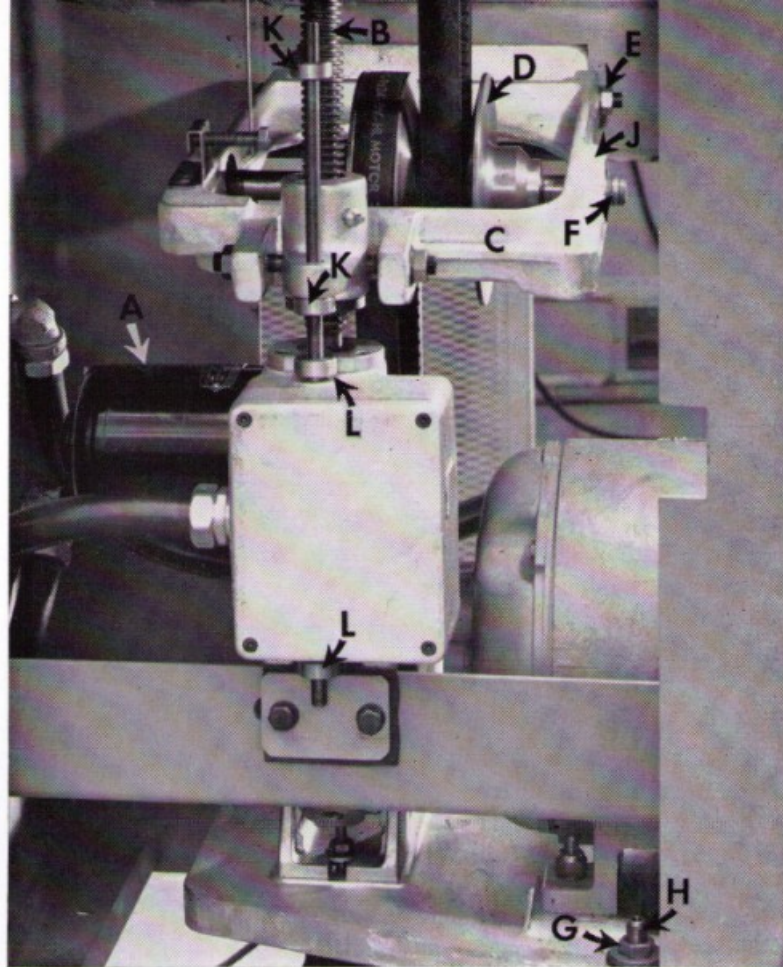

Figure 6

### Belt Adjustment — Figure 6

By raising or lowering the motor plate, proper belt tension can be obtained. Due to the construction of the driving unit the tension of the motor belt and spindle belt are automatically equalized. **BELT TENSION SHOULD BE CHECKED ONCE A WEEK**, especially when the machine is new.

To check belt tension, first set brake switch to "OFF". Start machine spindle — shut off and allow to coast to a stop. **THE BELTS SHOULD NOT BE STRETCHED, YET ADJUSTED SO THERE IS NO LOOSENESS.**

To tighten belts, loosen nut "G", Figure 6, and turn set screw "H" clockwise. Make adjustment in small amounts and run machine between each setting to permit belts to "equalize".

**IF BELTS SLIP WHEN ADJUSTED TO PROPER TENSION, THE MACHINE IS BEING OVERLOADED.** Centrifugal force tends to tighten belts when running.

## Belt Adjustment — Continued

After proper setting, lock nut "G", Figure 6, and reset brake switch to "BRAKE".

Drive shaft bearings located at "J", Figure 6, are precision ball bearing type, grease packed and sealed and require no further attention. Drive shaft "F", Figure 6, is coated with "MOLYLUBE" so it will slide freely.

The belts and driving unit are protected from "overtravel" by a set of stops "K", Figure 6. The two stops "K" are set at the factory and actuate electric limit switches and automatically shut off the speed changing mechanism when it reaches the low speed of 125 or the high speed of 3000. The two stops "L", Figure 6, are also set at the factory and are positive mechanical stops in case the electric limit switches fail. **NOTE:** If the speed changing mechanism does not work, check instructions on Pages 10 and 11.

### Spindle Driveshaft Brake

Figure 7

The spindle driveshaft brake is designed for rapid but gradual stopping of the precision headstock spindle. The brake is "tied in" with the control lever "A", Page 12, and is released when the machine is turned on and applied when the machine is turned off.

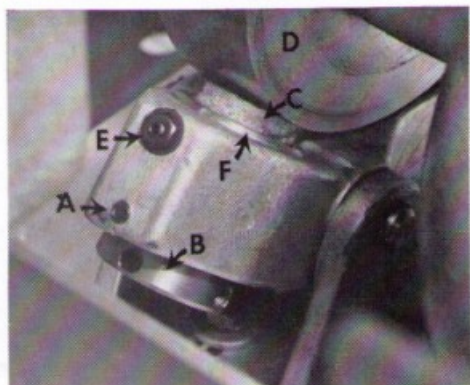

Figure 7

**TO RELEASE BRAKE** for a "FREE SPINDLE" turn brake switch to "OFF" as shown on Page 13. The brake drum "D", Figure 7, is located directly on the main motor drive shaft. The brake is actuated by a solenoid located under cover "A", Figure 8, Page 17 and is accessible from rear of machine by removing motor ventilator screen.

The brake shoe insert "C", Figure 7, is forced against the brake drum by means of a powerful spring. The spring automatically compensates for brake wear. However, after considerable use it may be necessary to adjust.

### To Adjust Brake — Figure 7

With brake in released or "OFF" position, loosen set screw "A", Figure 7 and turn adjusting screw "B" to the right with a pin wrench until there is .003" to .005" clearance between the insert "C" and drum "D".



## Spindle Driveshaft Brake — Continued

### After adjustment relock set screw "A", Figure 7

**DO NOT ADJUST "E"**, Figure 7, which has been set at the factory to hold alignment key for the brake shoe housing.

**DO NOT RUN BRAKE DRY.** Add a few drops of light oil to the brake drum periodically which will keep the brake insert pliable. If machine is braked often — oil daily. Braking time is from 2 to 3 seconds.

**CAUTION:** Do not allow brake insert to become worn enough to allow insert housing "F", Figure 7, to score brake drum.

**TO REPLACE BRAKE INSERT,** loosen set screw "A", Figure 7, and unscrew nut "B", Figure 7, and remove housing "F", Figure 7. Knock out old insert. Trim off small end of new insert until it bottoms and is a snug fit in tapered hole of housing. When reassembling, line up keyway of housing with key before starting adjusting nut "B", Figure 7. Set clearance to .003" to .005" as explained before and relock set screw "A", Figure 7.

Main drive motor "B", Figure 8, and variable speed motor "C", Figure 8, have grease sealed ball bearings and need no further attention.

Adjusting screws "D" and "E", Figure 8, are set at the factory and are for alignment of the countershaft in relation to main drive motor and spindle headstock pulley.

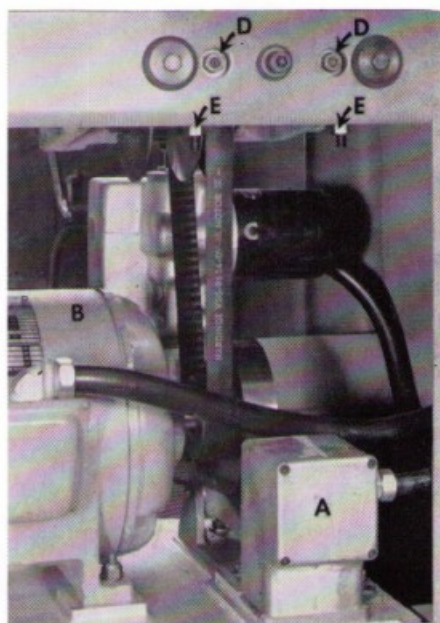

Figure 8

## TO REMOVE MOTOR BELT

1. Run countershaft carrier bracket to top position (highest spindle speed setting).
2. Turn brake control selector switch to "OFF".
3. Remove nut and steel washer from motor plate hold down bolt and raise motor plate 2" to 3" and block.
4. Remove brake drum from motor shaft by taking out four lock screws and set screws. The four keyways in the pulley brake drum are numbered. When removing pulley note the keyway number that the motor shaft key is in so it can be assembled in the same location.
5. Roll head belt off of countershaft pulley then slide countershaft pulley assembly to extreme right.
6. Pass head belt and motor belt around and off end of shaft.
7. Put new motor belt in place.
8. Replace head belt on countershaft and reassemble. FOR PROPER BELT ADJUSTMENT REFER TO PAGE 15.

## TO REMOVE HEADSTOCK BELT

1. Follow instructions "How To Remove Motor Belt" steps 1 through 5.
2. Pass head belt around and off end of shaft.
3. Remove switch pull rod that goes through belt.
4. Remove collet closer, see Page 23.
5. Remove handwheel snap ring and handwheel.
6. Remove handwheel spindle key, spring spacer and washer.
7. Remove both back covers from gear box.
8. Remove snap ring in front of idler gear bearing.
9. Screw push screw "in" to remove gear, shaft and bearing.
10. Remove lock screws in shifter yoke, unscrew shaft with 1/4"

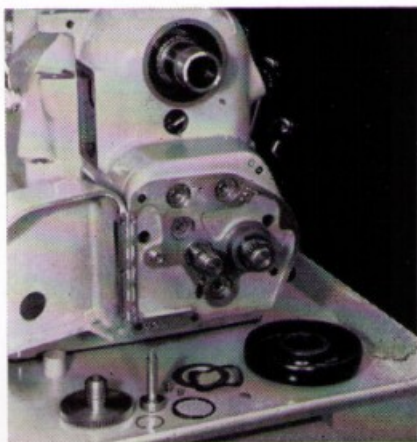
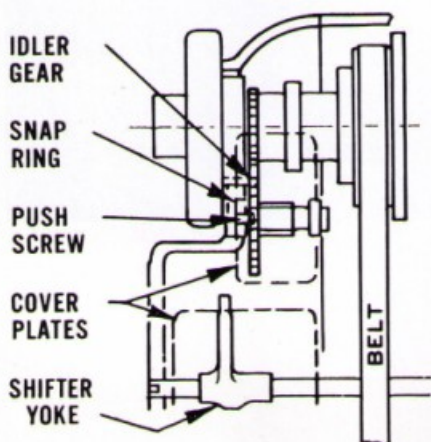



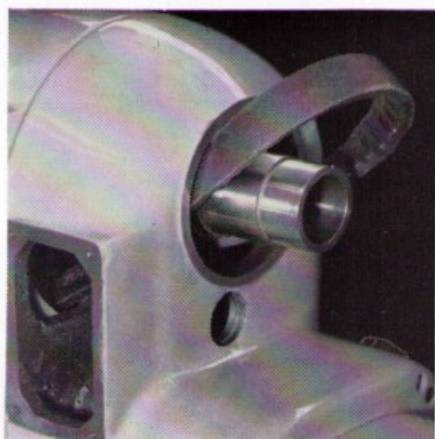

Figure A

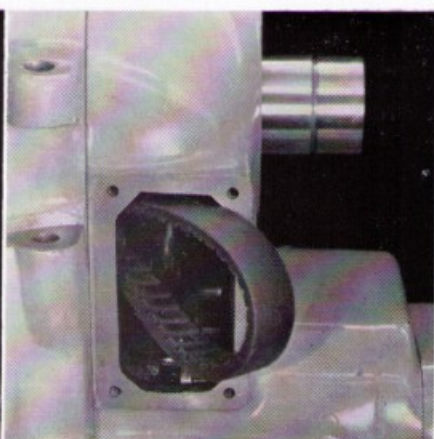
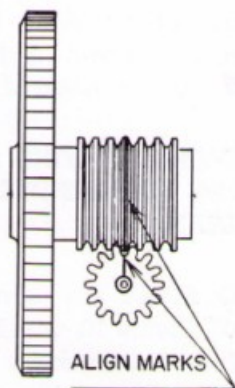

Figure B

hex key wrench in end of shaft and pull shaft part way out (approx. 5").

11. Use switch pull rod as hook and bring belt part way out opening and around end of spindle, as shown in "A" above, and then out through top opening in rear of gear box, as shown in Figure "B" above.
12. Tie weighted string around new belt and drop through opening for belt, to guide it down through gear box and pedestal. Install new belt as shown in Figure "A". Use switch pull rod to lift belt up on to spindle pulley.
13. Push shifter back in and screw in place. (Lever must be in vertical position).
14. Locate shifter yoke on shaft by lining up screw holes.
15. Replace idler gear, shaft, bearing and snap ring. Line up gears as shown in sketch at right.
16. Replace head belt on countershaft and reassemble. FOR PROPER BELT ADJUSTMENT REFER TO PAGE 15.



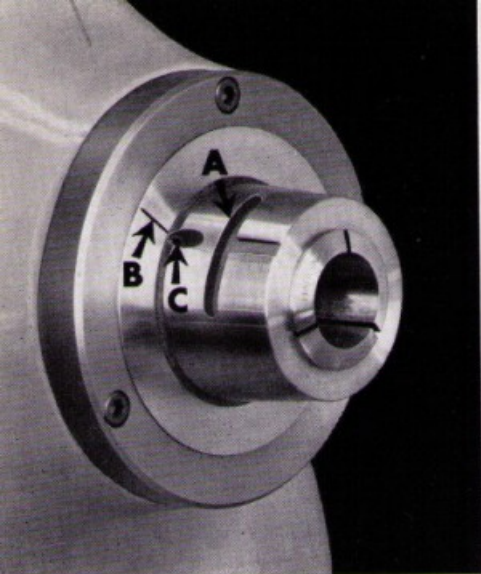

Figure 9

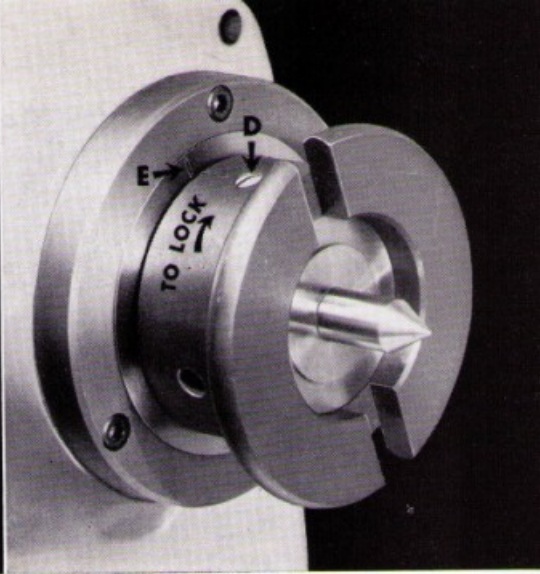

Figure 10

## HOW TO APPLY AND REMOVE SPINDLE NOSE TOOLING

Figures 9 and 10

The Hardinge Taper Nose spindle construction is time-proven for accuracy, durability and for fast, easy application and removal of spindle nose tooling. The precision ground slow taper holds and aligns all tooling. The pin in all headstock spindle nose tooling engages the bayonet slot "A", to draw the attachment securely on the taper. Once securely drawn up, the spindle nose attachment is actually driven by the locking action of the tapered surface.

**BEFORE APPLYING ANY ITEM OF TOOLING TO THE SPINDLE NOSE WIPE THE SPINDLE NOSE AND ATTACHMENT MATING SECTION CLEAN.**

**TO APPLY** the drive plate for driving dog, for example, align key "D", Figure 10, with bayonet slot and slide drive plate on spindle nose. When it is back as far as it will go turn the drive plate clockwise to lock in place. This is determined by the relation of the key "D" and spindle reference line "E". Final tightening should be done with a standard pin type spanner wrench. (Use Williams or Armstrong spanner wrench No. 460. Do not use hammer and punch.)



**TO REMOVE** the drive plate, turn counterclockwise with spanner wrench to loosen. Continue to turn until key "D" is in line with reference mark "E", then remove from spindle by sliding to right off end of spindle.

**IMPORTANT** — to obtain accurate results from precision spindle nose attachment always be sure the spindle nose and mating section in attachment are **CLEAN BEFORE THEY ARE ASSEMBLED TOGETHER.**

**DO NOT REMOVE KEY "D" TO REMOVE SPINDLE NOSE TOOLING. IT IS THE SLOW WAY AND WILL INTERFERE WITH FUTURE ACCURATE OPERATION OF THE ATTACHMENT.**

### **SPINDLE COLLET KEY — Figure 9**

The spindle collet key "C", Figure 9, is threaded into the spindle and can be removed and replaced, in the event of wear or damage, without removing the headstock, spindle or spindle bearings. Use a 3/32" hexagon pin wrench to remove lock screw; then remove collet key screw with same hexagon pin wrench.

### **LUBRICATION OF HEADSTOCK SPINDLE BEARINGS**

The headstock spindle is mounted on precision preloaded ball bearings. The preloading and resulting load carrying capacity is engineered to take radial thrust or end thrust, or a combination of both.

The precision preloaded ball bearings are grease-packed for life and require no further lubrication. The entire bearing assembly is housed as a unit and is properly sealed to exclude dirt and foreign matter. The spindle bearing seals are designed to operate at high speed without wear or friction.

There are occasions on a new machine when some of the excess grease in the spindle bearings will work its way out of the opening at the bottom of the front bearing cap. The appearance of this excess grease does not affect the spindle bearings nor the fact that they are grease packed for life.

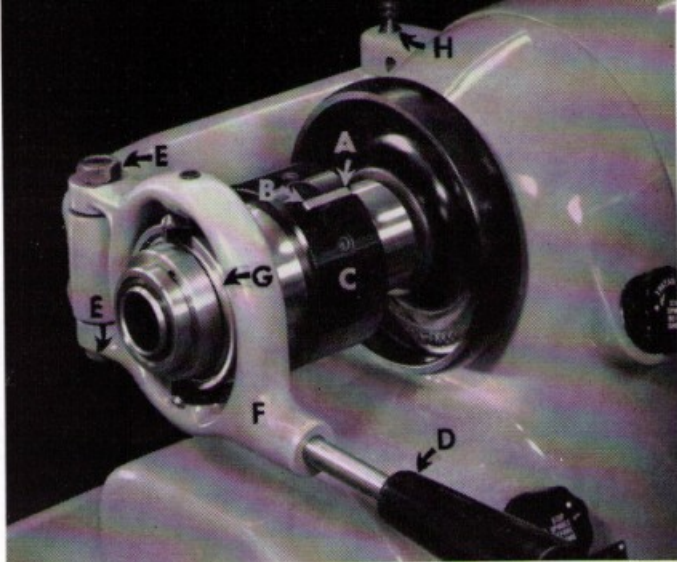

Figure 11

### ADJUSTING COLLET CLOSER — Figure 11

1. Apply the desired size collet or step chuck to the machine spindle. Be sure the collet or step chuck and spindle are clean.
2. Open collet closer latch "A", Figure 11, by pressing down at point "B".
3. Engage the collet closer tube on the collet or step chuck and thread about two turns only. To turn the collet closer tube, the operator, using his left hand, turns the black shell guard "C", Figure 11, forward while he holds the collet or step chuck in place with his right hand.
4. Place a work piece in the collet or step chuck.
5. Move lever "D", Figure 11, to the extreme left or closed position and then turn shell guard "C" toward the operator until it is drawn up as far as it will go by hand. If headstock spindle should turn, lock spindle by pressing in spindle lock pin "D", Figure 3, Page 12. To engage lock pin into notches provided, turn the spindle by hand until pin enters notch to lock.
6. Move lever "D" forward to the released position and turn shell guard "C" toward operator so that latch "A" advances two notches on the adjusting nut.
7. Close latch "A" and test collet closer for tension on work. Should additional gripping pressure on the work be required, open latch "A" and turn shell guard "C" toward operator. For less gripping pressure, turn shell guard "C" away from operator.

The two adjusting screws and lock nuts located at "E", Figure 11, are set at the factory. By adjustment of lock nuts "E", lever yoke "F" is raised or lowered so there is no pressure on bearing "G".



## HOW TO REMOVE COLLET CLOSER — Figures 11 and 12

The collet closer should be removed from the machine when using jaw chucks, face plates, fixture plates or other nose type fixtures.

Running the machine with the collet closer in place **without a collet** will cause damage to the collet closer.

To remove the collet closer remove link pin "H", Figure 11. This pin is easily removed by the use of a mallet and brass punch, striking pin at bottom.

**CAUTION: DO NOT REMOVE COLLET CLOSER BY REMOVING SCREW "E",** Figure 11. This screw is adjusted properly at the factory for proper operation of collet closer. Remove link pin "H", Figure 11, only. After removing pin "H" remove collet closer as shown in Figure 12. It is then necessary to remove adjusting nut "A", Figure 12. This is done by pulling nut straight off end of spindle. **DO NOT TURN ADJUSTING NUT — IT IS NOT THREADED TO SPINDLE.**

The collet closer should be removed periodically for cleaning to prevent loading of chips between collet closer tube and inside of spindle at rear end.

## APPLYING COLLET CLOSER — Figure 12

Clean the inside of the headstock spindle before applying collet closer. Also, clean outside diameter at rear of spindle where adjusting nut locates. Clean collet closer tube inside and out.

Apply a film of light oil on rear of headstock spindle and apply adjusting nut "A", Figure 12. Apply a film of light oil on bearing section "B", Figure 12, of collet closer tube and slide closer on machine and insert link pin "H", Figure 11.

**SLIDE COLLET CLOSER TUBE INTO HEADSTOCK SPINDLE CAREFULLY. DO NOT FORCE.** If it does not go in easily, remove and check for dirt, chips or burrs.

**CAUTION:** When threading draw tube onto collet and it does not turn freely by hand, remove it at once and check collet threads and draw tube threads, looking for dirt, chips or damaged threads. Also check inside diameter at rear end of headstock spindle and outside rear bearing diameter of draw tube.

Figure 12

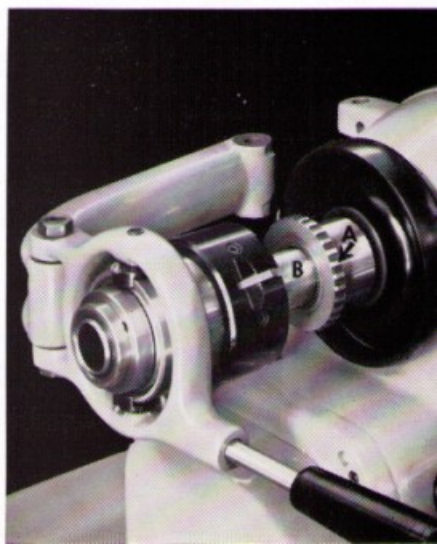

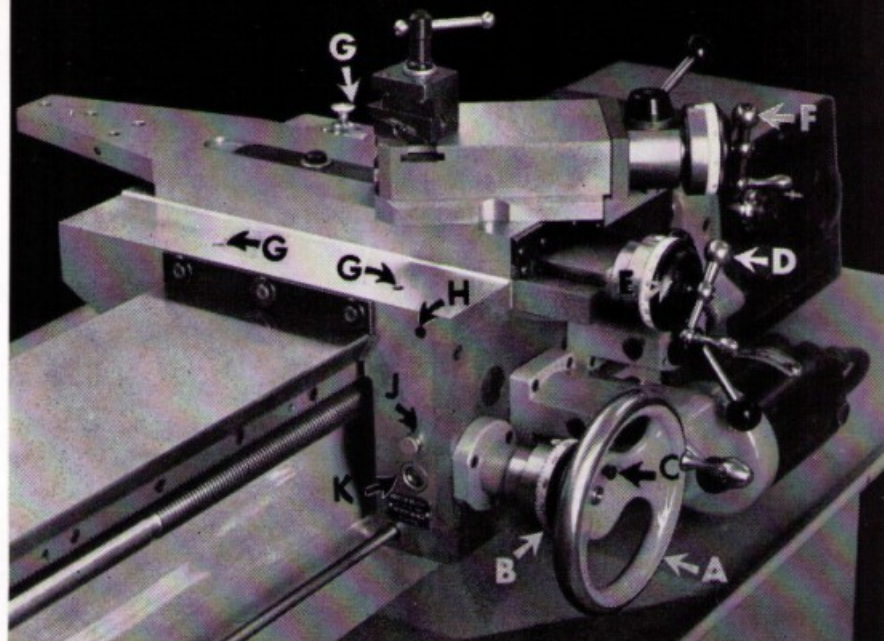

Figure 13

### CARRIAGE AND APRON — Figure 13

Carriage handwheel "A" is used to move carriage along bed — longitudinal movement. The adjustable white dial "B" is divided in increments of .010" and has a positive lock "C".

Cross Feed Screw Ball Crank Handle "D" is used for hand feeding cross slide. The black and white dial is adjustable and has positive lock "E". The dial is divided in increments of .001" and is **DIRECT READING**. Direct reading means that when cross slide is moved one graduation or .001" the cutting tool will remove .001" from diameter of work.

Compound Slide (tool post slide) Ball Crank Handle "F" is used to feed the compound slide. The adjustable black and white dial is divided in increments of .001" and has a positive lock.



## CARRIAGE AND APRON — Continued

Three follower rest mounting holes "G", Figure 13 are plugged with a screw to keep clean until used.

Tapped hole "H", Figure 13, is for mounting carriage indicator stop. The hole is plugged with a screw to keep it clean until used.

The micrometer portion of the stop is clamped to the dovetail bed. See Page 58. Power Feed Clutch for carriage (longitudinal feed) "A", Figure 14, controls feed of the carriage along the bed. To release clutch, press lever down to position shown.

Power Feed Clutch for cross slide "B", Figure 14, controls power cross feed. Raise ball handled lever to engage and push down to release.

Lead screw nut handle "C", Figure 14, is to engage lead screw nut for threading only. Handle is shown in released position. To engage move to right to horizontal position. See Page 30 for complete instructions on threading.

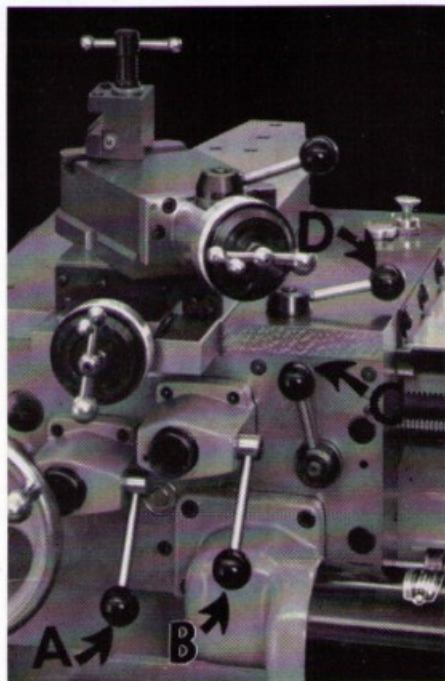

Figure 14

Carriage lock "D", Figure 14, is used to lock carriage in a fixed position on the bed when doing heavy facing operations. Handle is shown in released position — to lock pull forward.

### Apron and Clutch Lubrication

Lubricate carriage clutch and apron once a week at "J", Figure 13, Page 24. Maintain oil level in sight gage "K", Figure 13. Use Mobilfluid 200, a Mobil product, automatic transmission fluid type A or equal. Change oil every 60 days using drain plug located at bottom of apron.



Figure 15

## POWER FEED CLUTCH ADJUSTMENT FOR CARRIAGE AND CROSS SLIDE

Figure 15

The power feed clutches are of the friction type designed to slip when overloaded, which protects the tool as well as the machine.

The clutches are a spring loaded arrangement and cannot be adjusted for more pulling power. If the clutch slips under cut it is a sign of improper or dull tool or excessive feed.

The clutch adjustment is necessary for assembly purposes and is set at the factory and should not be changed. If for some reason the clutch is taken apart it is necessary to readjust. To reach nut for adjustment remove metal cover as shown at "A" and "B", Figure 15. Cover is threaded and has two spanner holes. Use 1/2" end wrench and adjust as shown at "B", Figure 15. When properly adjusted clutch will "release" when ball lever is about 15° below horizontal.

Three holes "A", Figure 16, in cross slide are for positioning and locking taper attachment. Hole "B", Figure 16, is for mounting coolant hose and nozzle supporting bracket and "C", Figure 16, is tapped hole for locking screw for bracket.

Bolt "D", Figure 16, is to release cross slide nut when using taper attachment. See Page 56 for complete instructions on taper attachment.

Cover "E", Figure 16, encloses tool post slide screw. It is necessary to remove cover before removing slide. It is good practice to occasionally remove slide for cleaning and lubrication of screw and nut.

Figure 16

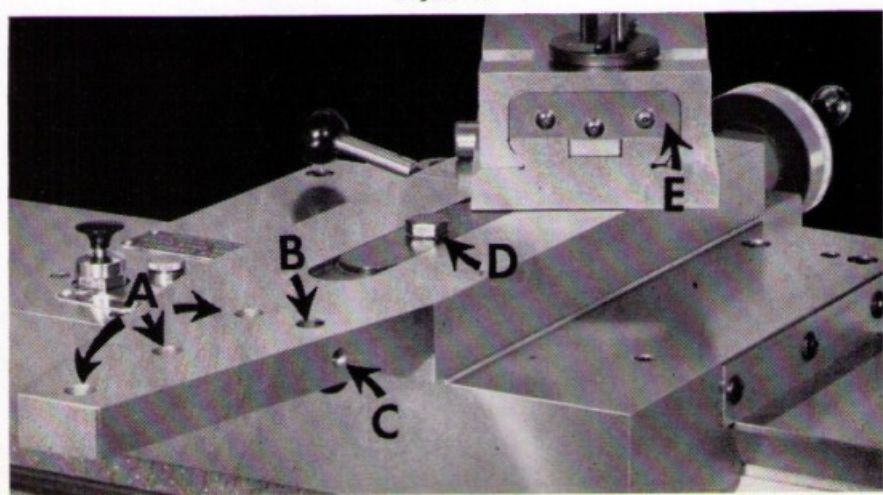



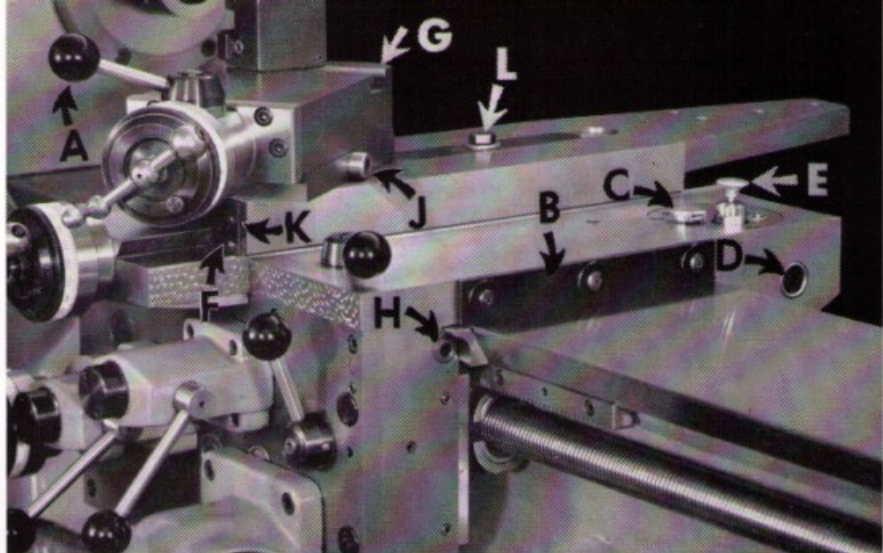

Figure 17

The quick acting handle "A", for compound slide, Figure 17, is used when threading or turning to withdraw tool on return of carriage.

Carriage bed wipers "B", Figure 17, are of hardened and ground steel mounted at both ends of carriage. Wipers are spring backed to hold wiper to carriage.

### CARRIAGE AND BEDWAY LUBRICATION

Fill pressure lubricator reservoir at "C", Figure 17. Use MOBIL VAC-TRA Oil No. 2 a Mobil product or equivalent. Sight gage "D", Figure 17, will indicate oil level. To lubricate bedways and carriage, pull plunger "E", Figure 17, up as far as it will go, then release and allow to return of its own accord. Operate as often as necessary to keep bedways wet with oil or a minimum of once a day.

### COMPOUND SLIDE LOCK

The compound slide swivels for the turning of angles or to set at 59° for threading. To turn slide for an angle setting, loosen eccentric draw bolt, "J", Figure 17, with 5/16" hexagon wrench. When tightening draw bolt, turn clockwise as if it were a right hand thread.

## CARRIAGE, CROSS SLIDE AND COMPOUND SLIDE GIB ADJUSTMENT

**CARRIAGE GIB ADJUSTMENT:** After considerable use it may be necessary to adjust the carriage gib. The gib is the tapered type and adjustment is made at "H", Figure 17, Page 27, as described below.

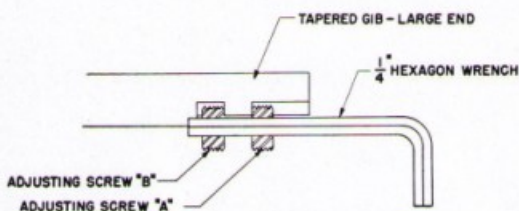

1. Insert 1/4" hexagon wrench in adjusting screw "A".
2. Loosen one full turn.
3. Push wrench on through into adjusting screw "B".
4. Advance adjusting screw "B" a fraction of a turn.
5. Pull wrench out of "B" and tighten "A".
6. Test carriage for "feel" — the carriage should have a slight drag, but should not bind.

Cross slide gib is adjusted in same manner at "F", Figure 17, Page 27. Compound slide gib is adjusted at rear of slide at "G".

**NOTE: Excessive gib pressure or drag does not improve machine performance.**

### TO REMOVE CROSS SLIDE

It is good practice to occasionally remove the cross slide. To do this first remove cover "K", Figure 17, Page 27. Turn the cross slide feed screw ball handle clockwise until the slide comes off the back side of the carriage. With slide removed it is easy to lubricate cross feed screw and nut and to clean the slide ways. Use care when re-engaging the cross feed nut and screw. Bumping will bend the first thread of the nut causing it to bind on the screw. Loosen nut "L", Figure 17, Page 27, a few turns then push slide on until cross feed nut touches end of cross feed screw. Engage screw and nut by turning ball crank handle counterclockwise. Tighten nut "L" and reposition slide. Replace cover "K".

### TO ADJUST BACKLASH

To adjust backlash in cross feed screw, remove bolt "A" and cover "B". Loosen cap screw "C". Turn adjusting screw "D" clockwise to reduce backlash. As adjusting screw "D" is tightened, check cross feed screw by turning crank to prevent over tightening. Tighten cap screw "C" and replace cover "B" and bolt "A", then test for backlash.

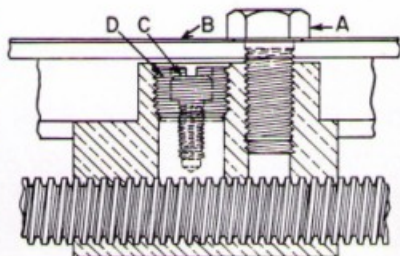



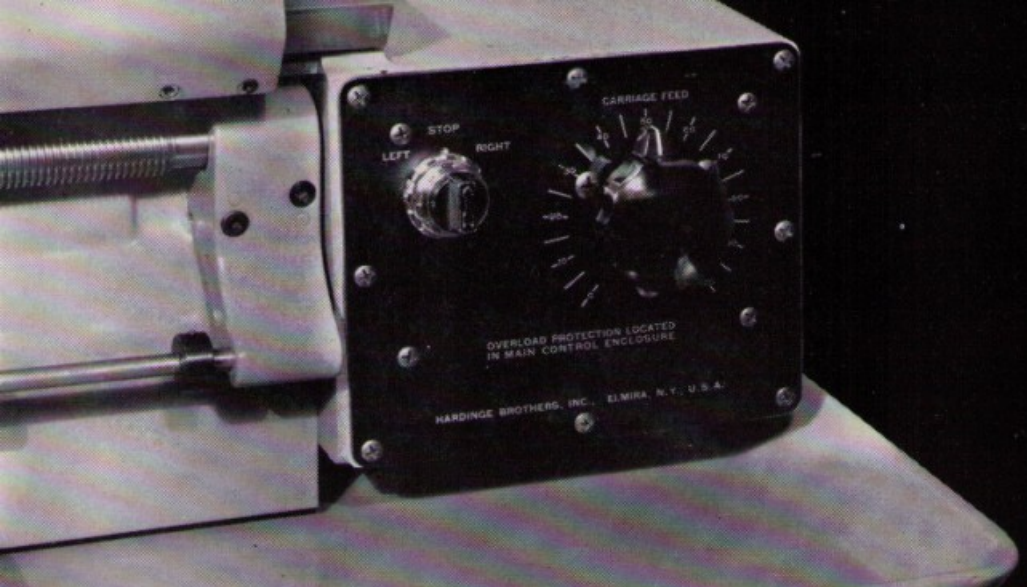

Figure 18

### POWER FEED FOR CARRIAGE

The carriage feed is powered by a direct current, totally enclosed, ball bearing motor mounted on the carriage. The motor is connected to the clutch assembly by a worm gear.

110 volt alternating current is fed from the main electric control panel at the left-hand end of the pedestal base to the power feed control panel at the right-hand end of the machine. Here it is converted by selenium rectifiers to direct current for the power feed motor. The electric cable from control panel to power feed motor is of oil resistant neoprene.

To start the power feed, position the **"SELECTOR"** switch to the **"LEFT"** position. Machine must be running before power feed will operate.

The **"LEFT-RIGHT"** switch is used to reverse the power feed motor. Select the direction of feed required by positioning the **"LEFT-RIGHT"** selector switch accordingly. When placed in **"LEFT"** position carriage will feed toward left or toward headstock. When in **"RIGHT"** position carriage will feed toward right. When placed in **"STOP"** position power feed motor is off.

In operation, the carriage is advanced with the handwheel until the turning or boring tool is next to the work. Then, the carriage clutch is engaged. The rate of carriage feed can then be increased or decreased by turning the feed control knob on the electric control panel. The rate of feed is determined by material being cut and the finish required. The rate of feed may be changed while the tool is under cut. Experience has shown that it is best to make a few sample pieces to determine the spindle speed and rate of feed that is best suited to give desired surface finish and production rate. When making the test run, record the number at which the power feed control knob was set when best results were obtained. Then, on the production run the operator can set the control knob to the reference numbers on the face of the control panel and obtain the same results as the test run. They do not represent either thousandths per revolution or inches per minute.

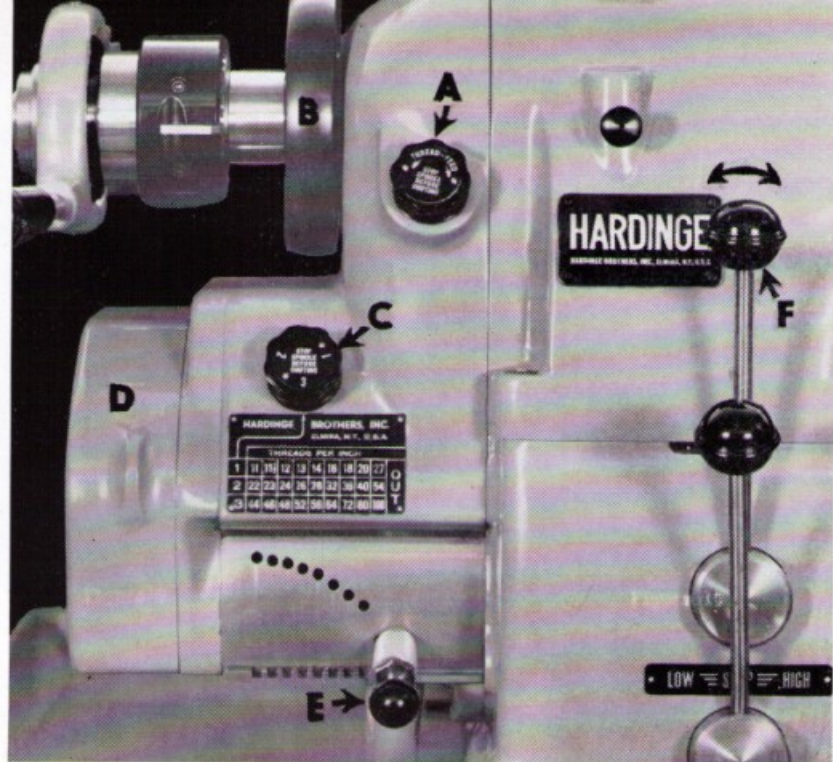

Figure 19

### GEAR BOX FOR THREADING ONLY — Figure 19

Precision threading is an outstanding feature on the Hardinge HLV-H lathe. The logical separation of the power feed and lead screw gear box reserves the precision gear box for threading only, assuring maximum precision for the lead screw drive.

The all steel gears within the gear box run on shafts mounted on ball bearings. These bearings are grease packed and sealed, requiring no further attention.

### TO ENGAGE GEAR BOX

To engage the gear box turn knob "A", Figure 19, counterclockwise in the direction of arrow marked "THREAD". When turning knob "A" the teeth of the sliding gear within the gear box may not mesh with the headstock spindle gear teeth. If so, turn the headstock spindle by means of spindle handwheel "B", Figure 19.



**IMPORTANT:** Before turning spindle, release spindle brake to obtain free spindle — see instructions on Page 13. While turning spindle also turn knob "A", Figure 19, to left until a definite click is heard.

**IMPORTANT:** Knob "A", Figure 19, should always be set in the "Feed" position except when threading, thus disconnecting gear box from headstock spindle.

The Hardinge HLV-H Lathe quick change gear box permits instant selection of 27 different threads by shifting a lever and turning a knob.

Knob "C", or three change knob, Figure 19, has three numbered positions — 1, 2 and 3. These numbers correspond with the 1, 2 and 3 given at the extreme left side of the gear box thread chart plate. To select the proper thread, numbers 1, 2 or 3 on knob "C" must be set at the bottom position to line up with the pointing arrow. The knob is shown in the number 3 position in Figure 19. The tumbler or nine change handle "E" has nine positions — each lining up with gear box thread chart plate. Combining the three positions of the three change knob and nine positions of the tumbler handle, 27 changes are obtained.

### THREE CHANGE KNOB — Figure 19

When number one of knob "C", Figure 19, is in line with the arrow, any thread in row one of thread chart can be selected by changing the tumbler handle or nine change handle "E", Figure 19, to the desired thread in that row.

The three change knob "C", Figure 19, controls a sliding gear cluster. Number three on the knob, when lined up with the arrow on gear box chart, is in the center position. To place knob "C" in the number one position, turn to "RIGHT". Turn to "LEFT" to place number two position in line with arrow.

In the event the sliding gear cluster does not engage the other gears in the gear box properly to bring the desired number on three change knob "C" in line with arrow, open the change gear cover "D", Figure 19, and turn shaft "A", Figure 20, Page 33, by hand until the gears mesh properly.

## TUMBLER HANDLE OR NINE CHANGE HANDLE

To make a selection on the gear box thread chart, pull the spring pressured black knob "E", Figure 19, out as far as it will go and lower until it will move sideways to the desired notch directly under the thread required. Raise the handle and let plunger drop into hole. If the tumbler handle will not raise far enough to drop plunger into hole, open change gear cover and rotate shaft "A", Figure 20, see opposite page, until gears mesh and handle raises permitting plunger to seat.

At the extreme right on the gear chart is an "OUT" position which is used when change gears are set up outside the gear box for cutting threads not obtained within quick change gear box.

Fastened to the tumbler handle bracket within the gear box is a 5/16" round safety bar "C", Figure 20, that extends out through a hole in the left side of the gear box. This bar is to prevent applying change gears outside the gear box until the tumbler handle is placed in the "OUT" position.

### IMPORTANT

**Do not shift gears when machine is running.** The Hardinge HLV-H Lathe is a smooth running high speed machine and shifting of gears in the gear box when the machine is running will result in damage to the unit.



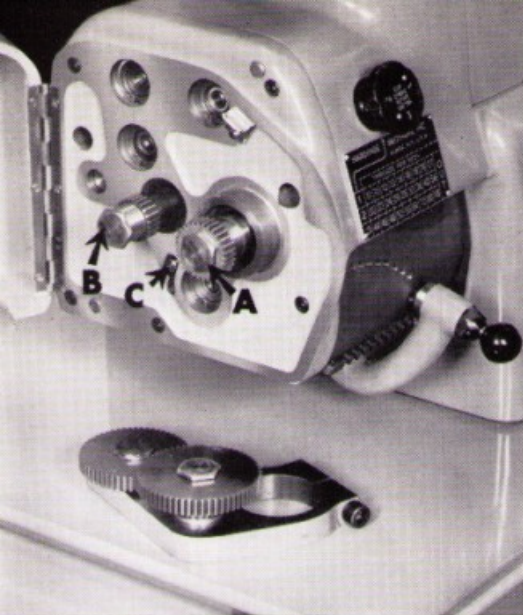

Figure 20

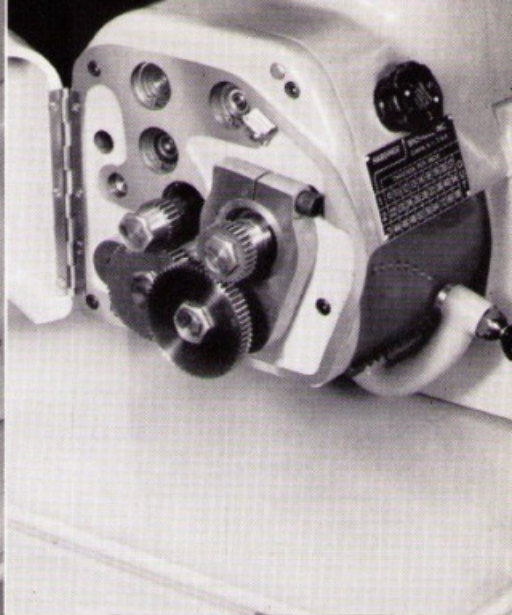

Figure 21

### OUTSIDE CHANGE GEARS — Figures 20 and 21

The outside change gears are used to cut threads not provided in the quick change gear box. A set of five gears and a bracket are standard equipment with each machine. These gears, when set up to the gear chart — see Page 34, will cut 10 threads per inch. Three of the gears are shipped on the bracket and the other two are in place on the shafts as shown in Figure 20, one on the end of the lead screw shaft "A", and the other on the end of the sliding cluster gear shaft "B".

Before setting up change gears, place tumbler in the "OUT" position.

To cut other threads which are not in the gear box, additional gears must be purchased — see Pages 34, 35, 36 and 37 where gearing charts are given for threads from 10 to 250 threads per inch.

**IMPORTANT:** — Lubricate bushings and shafts on change gear bracket with spindle oil each time a set up is made. If long run threading is involved, lubricate daily.

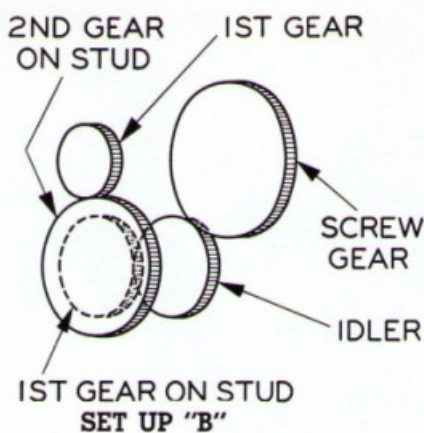
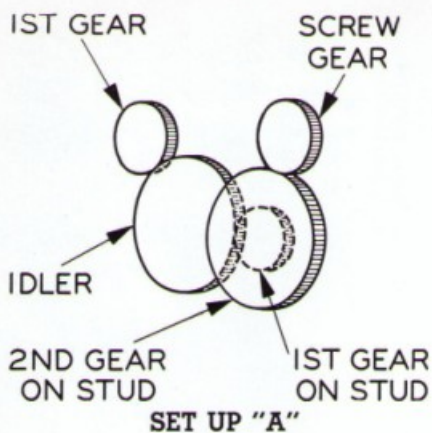

THREADS PER INCH	SET UP	KNOB	FIRST GEAR	FIRST GEAR ON STUD	SECOND GEAR ON STUD	SCREW GEAR	IDLER
10	A	2	22*	22*	60*	30*	55*
11				GEARBOX			
11½				GEARBOX			
12				GEARBOX			
13				GEARBOX			
14				GEARBOX			
15	A	1	40	None	30	60	44
16				GEARBOX			
17	A	1	40	34	30	60	44
18				GEARBOX			
19	A	1	40	38	30	60	44
20				GEARBOX			
21	A	1	40	42	30	60	44
22				GEARBOX			
23				GEARBOX			
24				GEARBOX			
25	A	1	40	50	30	60	30
26				GEARBOX			
27				GEARBOX			
28				GEARBOX			
29	A	1	40	58	30	60	30
30	A	2	40	None	30	60	44
31	A	1	30	31	22	66	44

\* Five gears supplied as standard equipment with machine.



<u>THREADS PER INCH</u>	<u>SET UP</u>	<u>KNOB</u>	<u>FIRST GEAR</u>	<u>FIRST GEAR ON STUD</u>	<u>SECOND GEAR ON STUD</u>	<u>SCREW GEAR</u>	<u>IDLER</u>
32				GEARBOX			
33	A	1	30	33	22	66	44
34	A	1	30	34	22	66	44
35	A	1	30	35	22	66	44
36				GEARBOX			
37	A	1	30	37	22	66	44
38	A	2	40	38	30	60	44
39	A	1	30	39	22	66	44
40				GEARBOX			
41	A	1	30	41	22	66	44
42	A	2	40	42	30	60	44
43	A	1	30	43	22	66	44
44				GEARBOX			
45	A	1	30	45	22	66	44
46				GEARBOX			
47	A	1	30	47	22	66	44
48				GEARBOX			
49	A	1	30	49	22	66	44
50	A	2	40	50	30	60	30
51	A	1	30	51	22	66	44
52				GEARBOX			
53	A	1	30	53	22	66	44
54				GEARBOX			
55	A	1	30	55	22	66	44
56				GEARBOX			
57	A	1	30	57	22	66	40
58	A	2	40	58	30	60	30
59	A	1	30	59	22	66	40
60	A	3	40	30	30	60	44
61	A	2	40	61	30	60	40
62	A	2	30	31	22	66	44
63	A	2	40	42	22	66	44
64				GEARBOX			
65	A	2	48	52	22	66	30
66	A	2	30	33	22	66	44
67	B	2	30	40	60	67	40
68	A	2	30	34	22	66	44

<u>THREADS PER INCH</u>	<u>SET UP</u>	<u>KNOB</u>	<u>FIRST GEAR</u>	<u>FIRST GEAR ON STUD</u>	<u>SECOND GEAR ON STUD</u>	<u>SCREW GEAR</u>	<u>IDLER</u>	
69	A	2	40	46	22	66	44	
70	A	2	30	35	22	66	44	
71	A	3	60	33	22	71	30	
72				GEARBOX				
73	A	3	60	33	22	73	30	
74	A	2	30	37	22	66	44	
75	A	2	40	50	22	66	44	
76	A	3	40	38	30	60	44	
77	A	3	60	33	22	77	30	
78	A	2	30	39	22	66	44	
79	A	3	60	33	22	79	30	
80				GEARBOX				
81	A	3	40	27	22	66	44	
82	A	2	30	41	22	66	44	
83	B	3	22	60	83	33	55	
84	A	3	40	42	30	60	44	
85	A	2	24	34	22	66	44	
86	A	2	30	43	22	66	44	
87	A	3	40	29	22	66	44	
88	A	2	30	44	22	66	44	
89	B	3	22	60	89	33	55	
90	A	2	30	45	22	66	44	
91	B	3	22	60	91	33	30	
92	A	2	30	46	22	66	44	
93	A	3	40	31	22	66	44	
94	A	2	30	47	22	66	44	
95	A	2	24	38	22	66	44	
96	A	2	30	48	22	66	44	
97	B	3	22	60	97	33	55	
98	A	2	30	49	22	66	44	
99	A	3	40	33	22	66	44	
100	A	3	40	50	30	60	30	
102	A	2	30	51	22	66	44	
104	A	2	30	52	22	66	44	
105	A	2	24	42	22	66	44	
106	A	2	30	53	22	66	44	
108				GEARBOX				



<u>THREADS PER INCH</u>	<u>SET UP</u>	<u>KNOB</u>	<u>FIRST GEAR</u>	<u>FIRST GEAR ON STUD</u>	<u>SECOND GEAR ON STUD</u>	<u>SCREW GEAR</u>	<u>IDLER</u>
110	A	2	30	55	22	66	44
112	A	2	30	56	22	66	40
114	A	2	30	57	22	66	40
115	A	2	24	46	22	66	44
116	A	3	40	58	30	60	30
118	A	2	30	59	22	66	40
120	A	2	30	60	22	66	40
122	A	3	40	61	30	60	40
124	A	3	30	31	22	66	44
125	A	2	24	50	22	66	44
126	A	3	40	42	22	66	44
128	A	3	30	32	22	66	44
130	A	3	48	52	22	66	30
132	A	3	30	33	22	66	44
134	B	3	30	40	60	67	40
135	A	3	40	45	22	66	44
136	A	3	30	34	22	66	44
138	A	3	40	46	22	66	44
140	A	3	30	35	22	66	44
142	B	3	22	60	71	66	30
144	A	3	40	48	22	66	44
145	A	3	48	58	22	66	30
146	B	3	22	60	73	66	30
148	A	3	30	37	22	66	44
150	A	3	40	50	22	66	44
160	A	3	24	32	22	66	44
170	A	3	24	34	22	66	44
180	A	3	30	45	22	66	44
190	A	3	24	38	22	66	44
200	A	3	24	40	22	66	44
210	A	3	24	42	22	66	44
220	A	3	30	55	22	66	44
230	A	3	24	46	22	66	44
240	A	3	30	60	22	66	40
250	A	3	24	50	22	66	44

## INSTRUCTIONS FOR THREAD CUTTING

The Hardinge HLV-H Lathe is designed for rapid and accurate thread cutting. Threads can be cut to a shoulder without fear of running into the shoulder since the automatic stops will stop the carriage at a pre-determined point in either direction.

Before starting to cut a thread, select the proper cutting speed for the size of thread to be cut and to give the best finish for the particular material being used. Maximum recommended threading speed is 1000 r.p.m.

Set the quick change gear box for desired pitch by engaging the tumbler handle as outlined on Page 32 and engaging the gear box by turning knob "A", Figure 19, Page 30 counterclockwise.

Set compound slide at 59° angle and position cutting tool in compound slide tool post. Position carriage so cutting tool is in the center of the part to be threaded.

Carriage control lever "F", Figure 19, Page 30, when moved to the left will cause carriage to move to the left. When the carriage control lever is moved to the right the carriage will move to the right. Carriage can be stopped manually at any time by placing carriage control lever in the center position as shown in Figure 19, Page 30.

Engage lead screw nut "C", Figure 23, by moving ball handled lever "D", Figure 23, to the right as shown. Making certain that lever "F", Figure 19, Page 30 is in the vertical position; set left carriage stop "A", Figure 22 and right carriage stop "B", Figure 23 approximately 1/2" from end of carriage. With threading tool away from work toward operator, make a trial run with the carriage. Pick up the exact relation between the tool and the shoulder or end of the thread by using top compound slide. Run carriage to right, checking stop "B", Figure 23, moving it to proper location so tool will clear end of work by 1/4".

**CAUTION:** Lock carriage stops securely before starting to cut threads. Do not release carriage nut "C", Figure 23, until threading operation is completed. **Do not use carriage stop when headstock spindle is running in reverse.**

**LEFT HAND THREADS** — can be cut the same as right hand with the spindle running forward except cutting pass is made from the headstock toward the tailstock. Carriage control stops are used for left hand threads as well as right hand threads.

(continued on page 40)



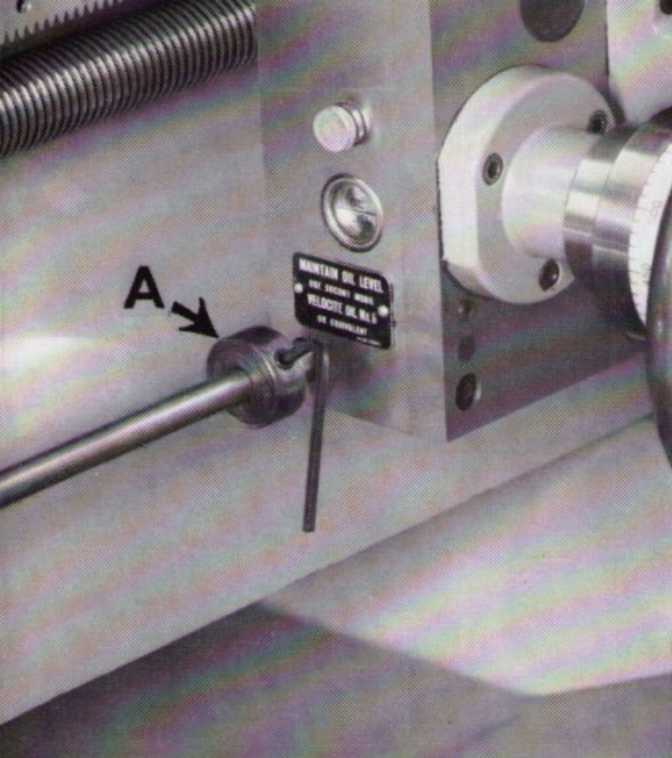
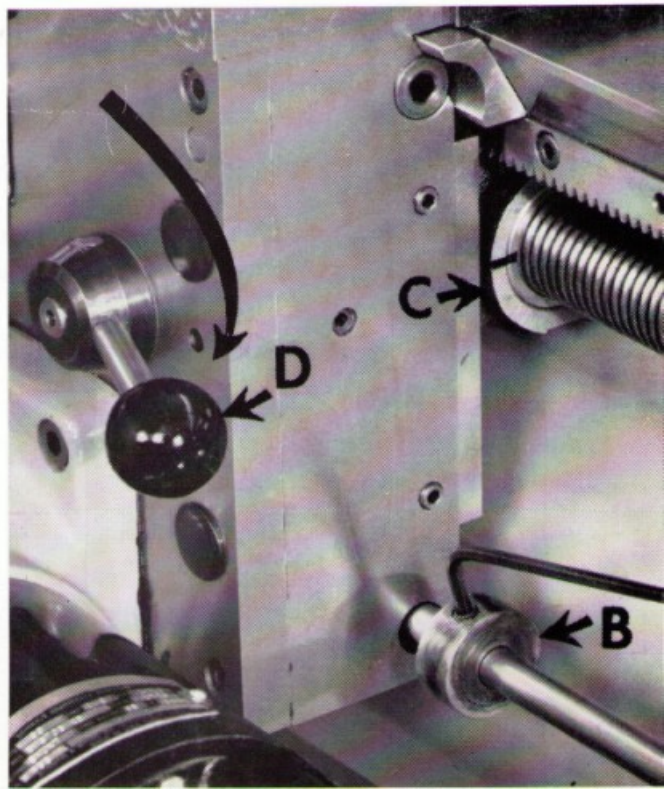

Figure 22

Figure 23



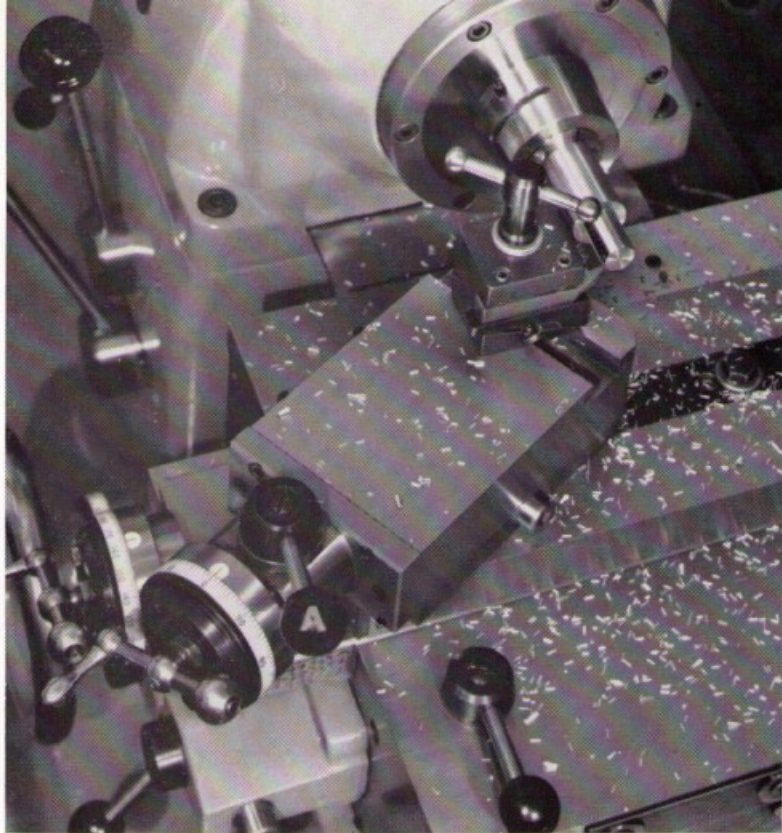

Figure 24

### THREAD CUTTING — continued

The illustration above shows the threading tool in position to start a threading pass. The carriage stop controlling the travel of the carriage to the right or toward the tailstock end of the machine when properly set places the tool about 1/4" from end of work.

When carriage is at rest and quick acting handle "A" is to the right in the cutting position, feed the cutting tool in the desired number of thousandths for the next threading pass.

Move lever "F", Figure 19, Page 30, to the left and carriage will start and move until it contacts stop at headstock end of machine stopping carriage as shown in Figure 25, Page 41.



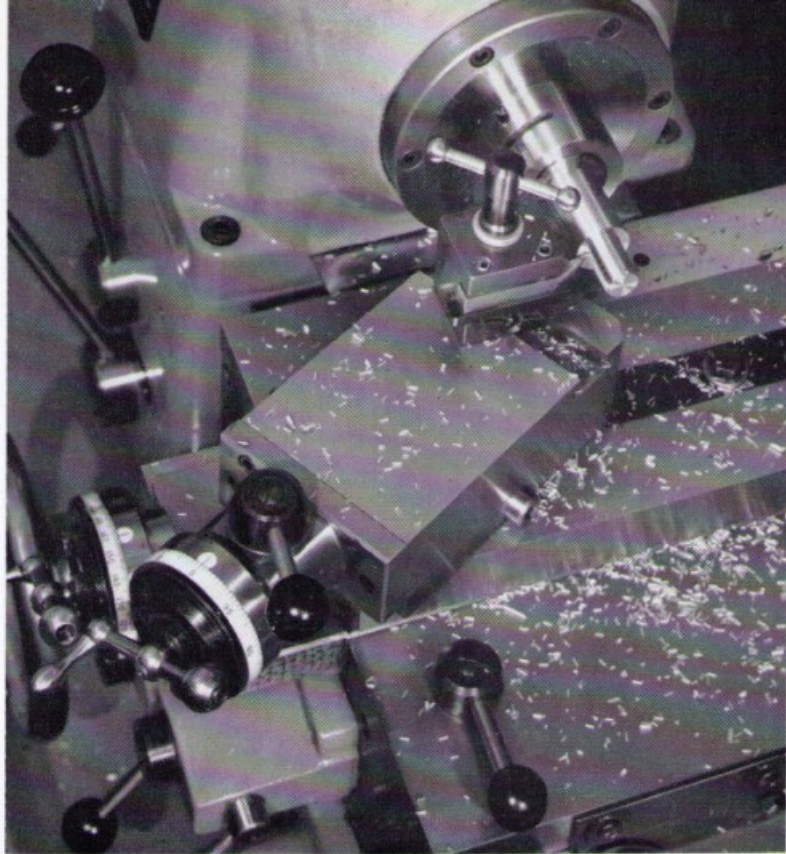

Figure 25

### THREAD CUTTING — continued

This illustration shows the cutter and carriage at the end of the threading pass. Notice that the threading tool is close to the shoulder — the carriage was stopped in this position by the carriage stop which controls the lead screw. Headstock spindle continues to run in the forward direction. Carriage stops cause only the gear box, lead screw and carriage to stop running.

When cutting left-hand threads, start the threading pass next to the shoulder and with the spindle running forward, make the threading pass toward the tailstock.

(Continued on Page 42)

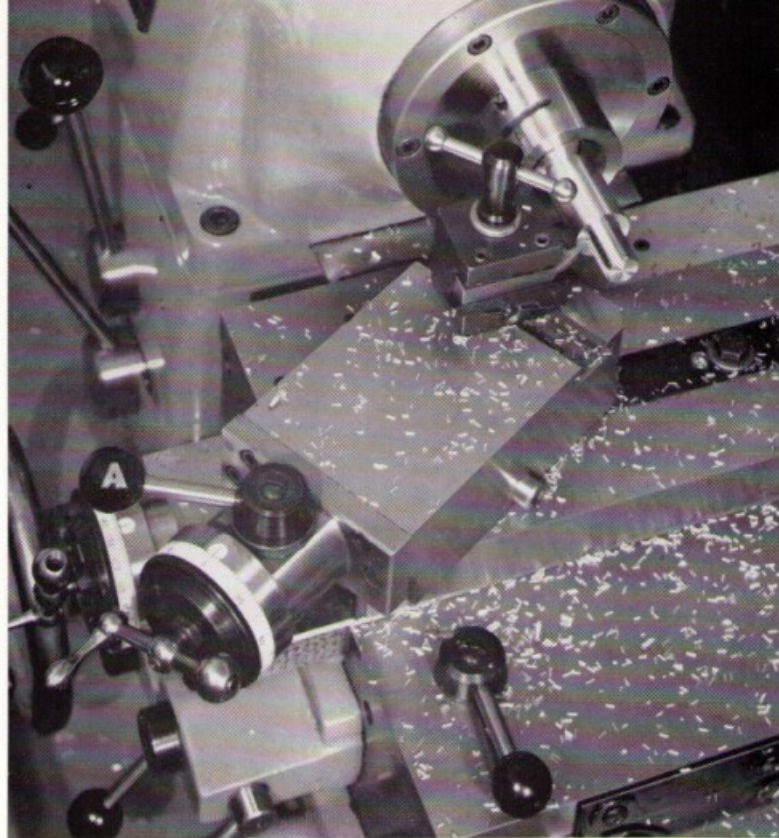

Figure 26

### THREAD CUTTING — continued

Illustrated above is the carriage in the same position on the bed as in Figure 25 only that quick acting handle "A" on the compound slide has been moved to the left withdrawing tool from work. After withdrawing tool with quick acting handle, the carriage is reversed or moved to the right to the starting position by moving carriage control lever "F", Figure 19, Page 30, to the right.



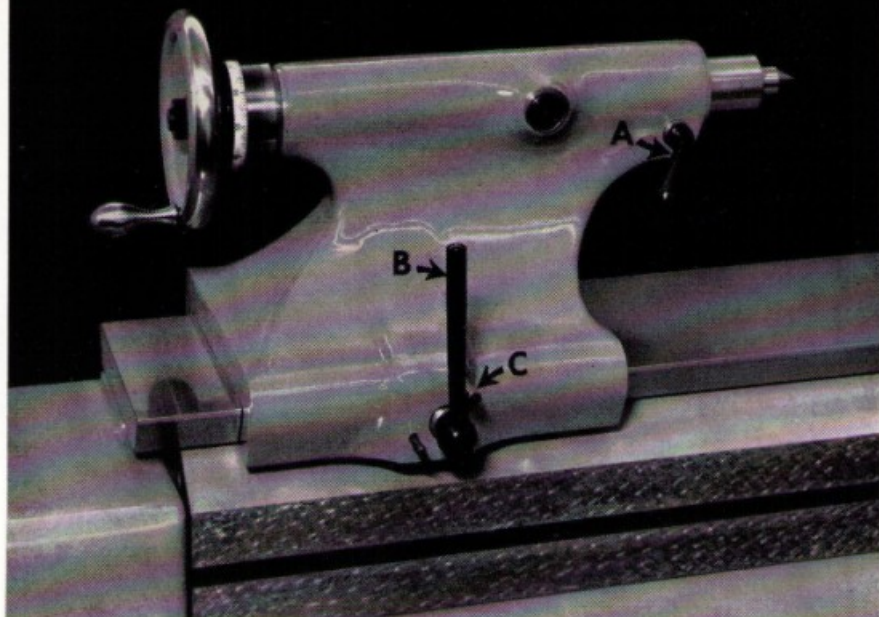

Figure 27

### TAILSTOCK — Figure 27

The tailstock is securely anchored to the dovetail bed by means of locking lever "B". To properly lock tailstock to bring it on center make sure lever is all the way against stop pin "C".

The hardened and ground spindle is divided in  $1/8$ " increments for the full  $3-3/4$ " travel. The handwheel has a black and white friction adjustable dial reading in  $.001$ " increments. The spindle takes standard No. 2 Morse taper shank centers and other tailstock tooling — see Pages 61, 62 and 63.

The spindle can be locked in any position by locking lever "A".

FLOOR PLAN

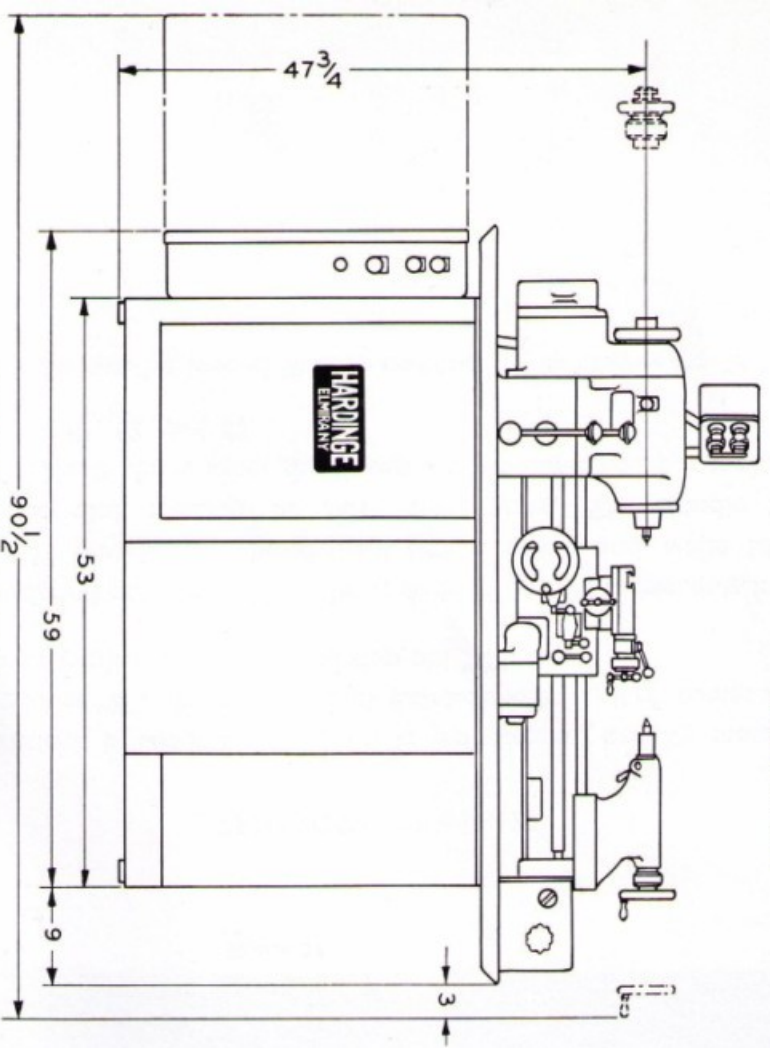

WITH SWITCH DOOR OPEN

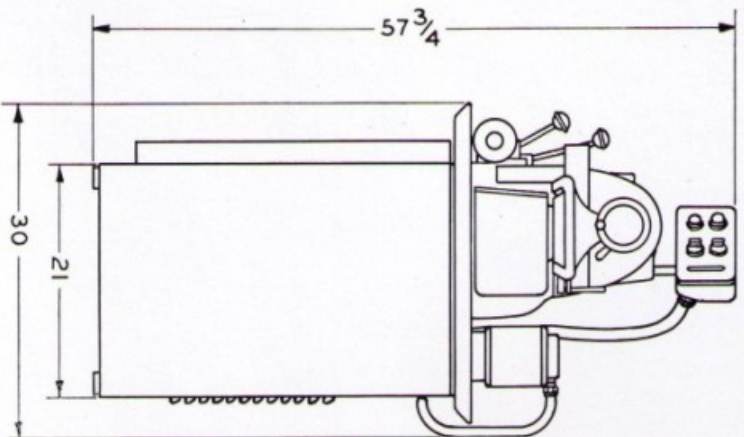



## MACHINE SPECIFICATIONS

Spindle Construction	. . . . .	Hardinge Preloaded Ball Bearing	
SPINDLE CAPACITY	{	With Step Chucks	1" to 6"
		With Jaw Chucks	5"
		With Jaw Chucks (Through Spindle)	1-5/32"
		With Round 5C HARDINGE Collets	1-1/16"
		With Hexagon 5C HARDINGE Collets	7/8"
		3/4"	
Spindle Nose	. . . . .	Hardinge Tapered	
Variable Spindle Speeds	. . . . .	125 to 3000 r.p.m.	
Swing Over Bed	. . . . .	11"	
Swing Over Carriage	. . . . .	9"	
Swing Over Cross Slide	. . . . .	5-3/4"	
Distance Between Centers	. . . . .	18"	
Range of Threads in Gear Box	. . . . .	11 to 108	
Number of Thread Changes in Gear Box	. . . . .	27	
Actual threads cut through gear box	— 11, 11½, 12, 13, 14, 16, 18, 20, 22, 23, 24, 26, 27, 28, 32, 36, 40, 44, 46, 48, 52, 54, 56, 64, 72, 80, 108		
NOTE: Standard threads in all standard English systems are included in the foregoing gear box selections.			
Compound Slide Travel	. . . . .	3"	
Power Feed Range	. . . . .	1/4 to 7" per minute	
Size of Lathe Tool:—Wedge Type (Standard Equipment)	. . . . .	3/8" x 3/8"	
	—Rocker Type (Optional Extra Equipment)	3/8" x 1"	
Tailstock Spindle Travel	. . . . .	3-3/4"	
Tailstock Spindle Taper	. . . . .	No. 2 Morse	
Approximate weight of machine with regular equipment listed below 1700 lbs.			

## REGULAR EQUIPMENT

**The Hardinge HLV-H Lathe is furnished complete with:**

- Fully enclosed headstock with preloaded ball bearing 1-1/16" collet capacity spindle.
- Drive Plate and Headstock Center.
- Ball Bearing Lever Collet Closer.
- Quick Change Gear Box reserved for precision cutting of 27 different threads.
- Set of five change gears.
- Completely Enclosed Carriage and Apron.
- Independent Electrical Variable Power Feed Drive for carriage and cross slide.
- Finger Tip Snap-Up Clutches for longitudinal and cross feed.
- Preloaded Ball Bearing Lead Screw for threading only.
- Automatic Lead Screw Stop with adjustable stop collars.
- Quick-acting Tool Post Slide for threading.
- Easy reading HARDINGE Black and White Feed Screw Dials.
- Easy reading HARDINGE Black and White Carriage Handwheel Dial.
- Solid Full Bearing Carriage.
- Solid Hardened and Ground Steel Dovetail Bed Ways.
- Full Bearing Tailstock with No. 2 Morse Taper.
- Welded Steel Pedestal with oil type chip pan and coolant sump.
- Oil Coolant Facilities (Illustrated Page 66)
- Tool Storage Compartment with Collet Trays.
- Variable Speed Driving Unit complete with 2-speed motor.
- Magnetic Electric Control Panel with transformer providing 110 volts for push button control circuit; time lag thermal overload relays provide overload protection; low voltage protection is also provided; cam operated, quick make and quick break forward and reverse switches; pilot light, fused disconnect switch interlocked with cover of panel — entire panel is one self-contained unit.

**Additional tooling items are shown on Pages 46 thru 68**

# HEADSTOCK SPINDLE TOOLING

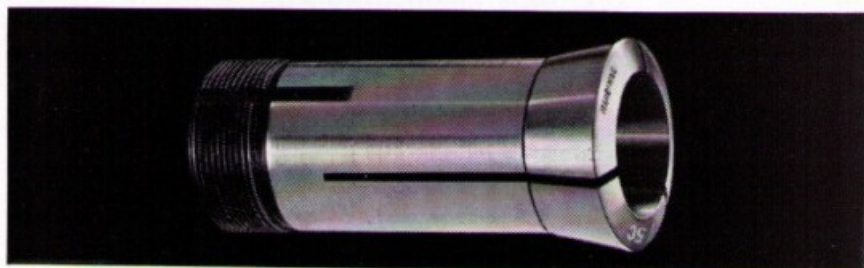

## 5C HARDINGE COLLETS

The Hardinge HLV-H Lathe takes 5C HARDINGE collets with capacity of 1-1/16" round, 7/8" hexagon and 3/4" square. Hardinge precision collets are manufactured to exact precision standards, and are available in all types and sizes for all makes of lathes and milling machines, as well as our own precision machines.

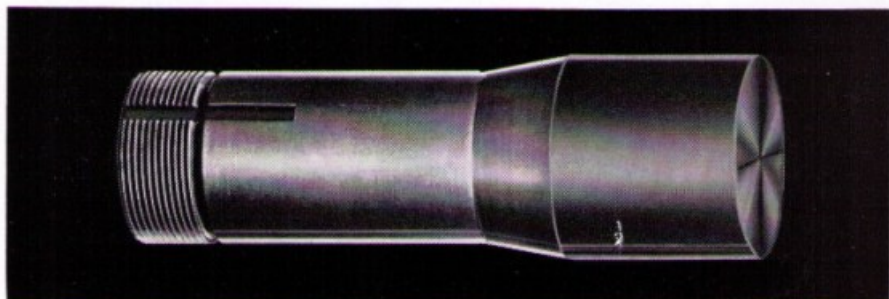

## 5C HARDINGE PLUG CHUCK

The collet shank section is finished for direct application to your machine spindle. The nose section is 1-15/32" in diameter and 1-3/4" long. It can be machined in place for the greatest degree of accuracy to suit your particular requirements for special arbors.

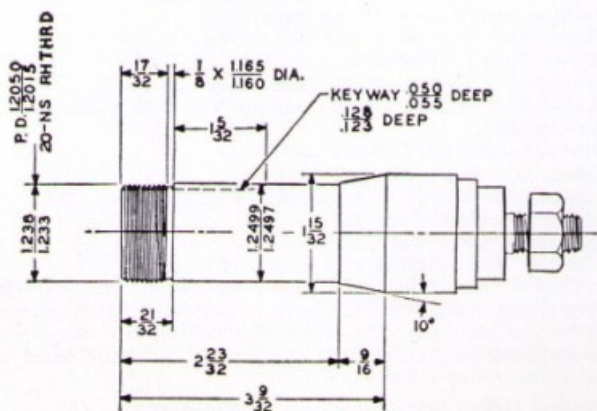



# HEADSTOCK SPINDLE TOOLING

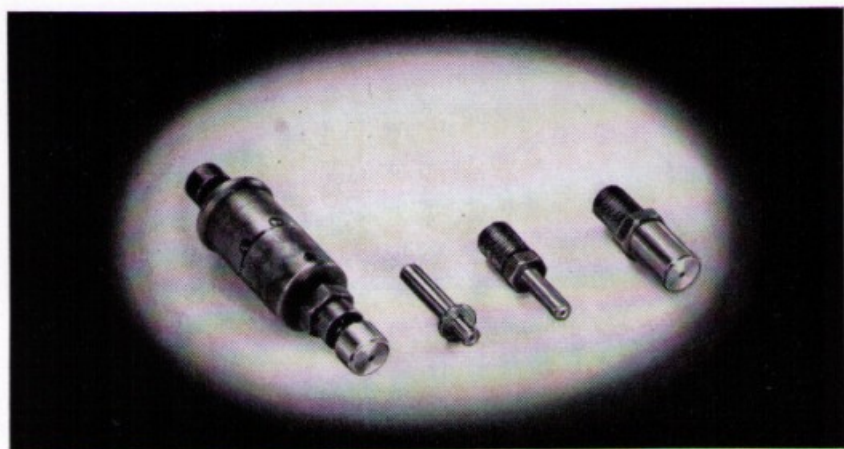

## UNIVERSAL COLLET STOP

This stop converts 5C HARDINGE collets into solid stop or spring ejector stop collets, without alteration of the standard collets. The application of this stop to the collet requires no machining. In other words, all collets used with this machine can be used in the regular manner or as solid stop collets or as spring ejector stop collets.

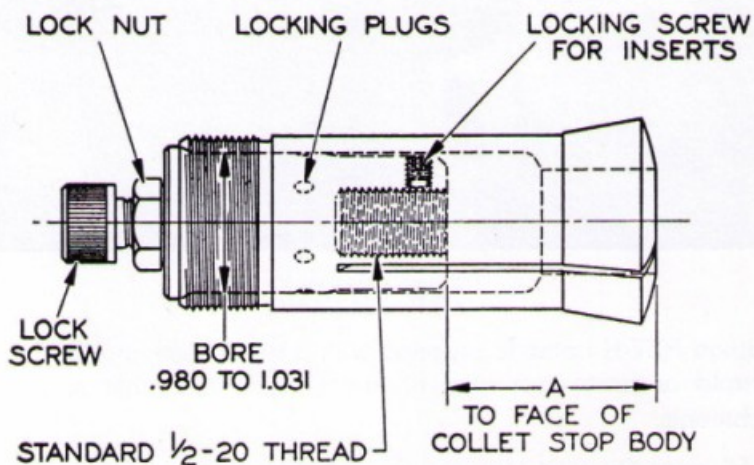

Dimension "A" is equal to 1-3/8" and is the maximum depth a part may be chucked using a solid stop. The maximum depth for spring ejector stop is 13/16". This is due to space required for spring ejector construction.

# HEADSTOCK SPINDLE TOOLING

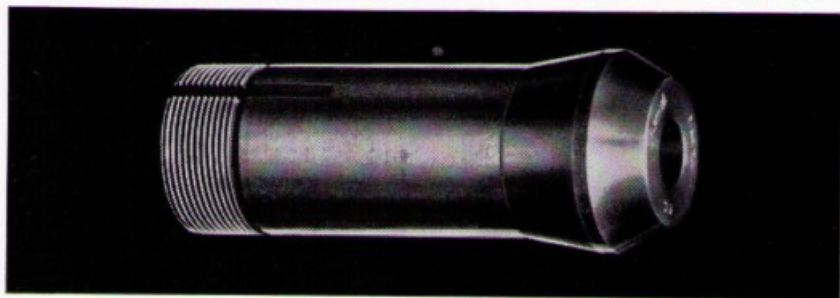

## 5C HARDINGE TAPER HOLE COLLETS

Hardinge 5C taper hole collets are hardened and precision ground for direct application to the headstock spindle. Available with No. 1 or 2 Morse Taper, 4, 5, 6 or 7 Brown & Sharpe Taper.

Taper hole collets are useful in making tools having tapered shanks and also when regrinding tailstock center.

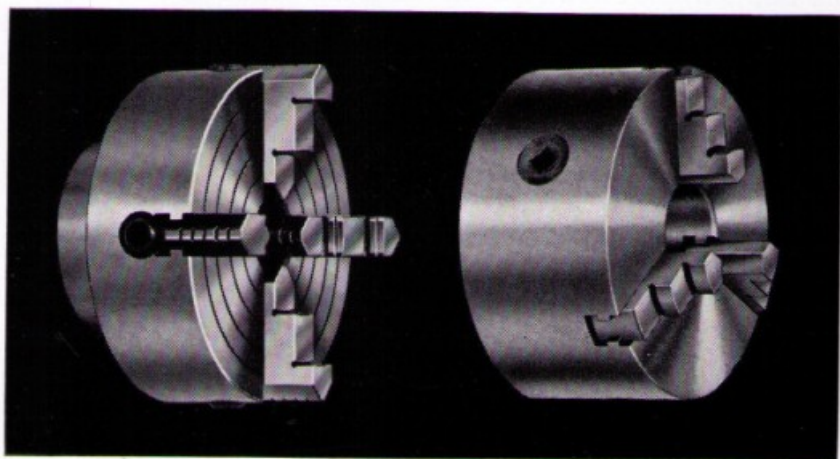

## JAW CHUCKS\*

Hardinge HLV-H Lathe is supplied with a taper nose headstock spindle for rapid accurate mounting of jaw chucks and other spindle nose attachments.

The 5" capacity four jaw and 5" capacity three jaw chucks, shown above, are available for use with the HLV-H Lathe.

These chucks are integrally mounted for direct application to the taper nose spindle, thus eliminating a separate mounting plate.

\* When ordering, specify for taper nose spindle and give machine serial number.



# HEADSTOCK SPINDLE TOOLING

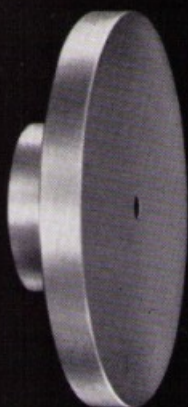

## FIXTURE PLATES\*

The fixture plate is machined all over for direct application to the headstock spindle. Three sizes are available; 3", 5" and 8-7/8" diameter. The flange section is 3/4" thick with a 7/16" center hole.

This plate can be machined to become a fixture or for mounting fixtures to hold work or for mounting special purpose chucks.



## 7" and 9" SLOTTED and TAPPED FACE PLATES\*

Are used for holding irregular shaped pieces. Holes are drilled and tapped to permit the use of standard 5/16" x 18 bolts.



FRONT VIEW



BACK VIEW

## ANGLE PLATE FOR FACE PLATE

The angle plate fastens directly to the T-slot of the face plate and is used to support work at right angle to the face plate. Work clamping surface is 1-1/2" x 3".

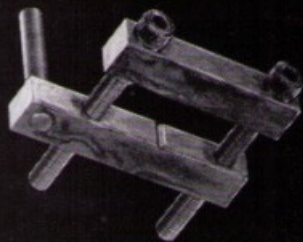

## DRIVING DOG

The driving dog is used in conjunction with the drive plate to drive work between centers.

\*When ordering, specify for taper nose spindle and give machine serial number.

# HEADSTOCK SPINDLE TOOLING

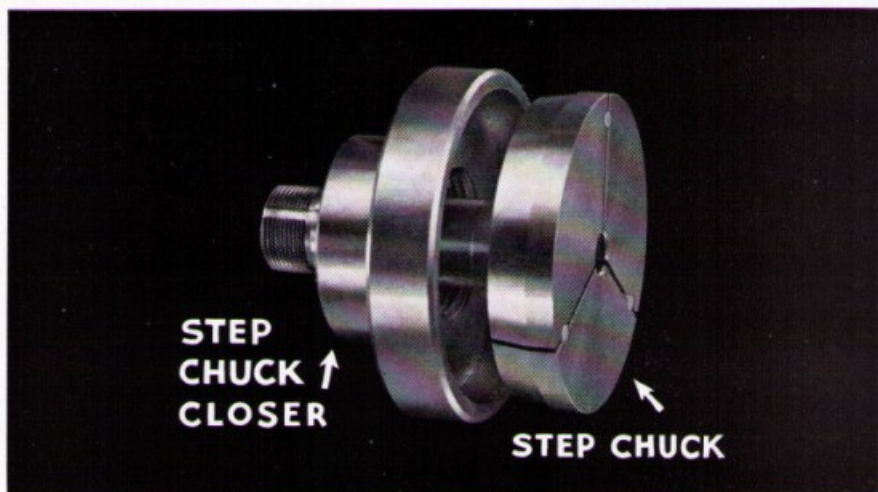

## 5C HARDINGE STEP CHUCKS

A step chuck is exceptionally useful for accurately holding work larger than 1-1/16" in diameter up to 6" in diameter. Tubing can be held without crushing or distorting. The step chuck will also hold castings, moldings, stampings and machined parts rigidly and accurately. The standard ball bearing lever operated collet closer is used to close the step chuck. The step chuck is closed by the taper on the periphery seating in the taper of the closer.

**REGULAR DEPTH CAPACITY** step chucks and closers are carried in stock in 2", 3", 4", 5" and 6" sizes for immediate delivery. They are 3/8" larger in diameter than the rated size, so the full capacity may be readily applied. Steps may be applied to a depth of 5/8" in these regular step chucks.

**EXTRA DEPTH CAPACITY** step chucks and closers are carried in stock in 2", 3", 4", 5" and 6" sizes. These step chucks are made so the full rated capacity step may be applied to the maximum depth of 1-1/4". An extra depth capacity step chuck closer is required for each size extra depth capacity step chuck.

## STEP CHUCK CLOSERS\*

A closer is required for each size step chuck. The closer fits directly to the machine spindle and has a taper corresponding to the taper on the periphery of the step chuck for closing the step chuck. A step chuck closer is required for each size step chuck to place the closing pressure over the stepped area of the chuck, resulting in greater gripping power and accuracy.

\* When ordering, specify for taper nose spindle and give machine serial number. Regular depth capacity step chucks and closers will be supplied unless extra depth capacity is specified.



# HEADSTOCK SPINDLE TOOLING

## ADVANTAGES OF USING STEP CHUCKS

Step chucks, developed by precision instrument makers, are a time proven method of holding work, rigidly and accurately. Step chucks take over on sizes above the regular collet capacity, providing collet-like accuracy, convenience, and precision results as with collets.

**WHEN USING STEP CHUCKS:** Analytical consideration of the gripping pressure applied on the work by a step chuck clearly shows one of the advantages of using step chucks. Note how

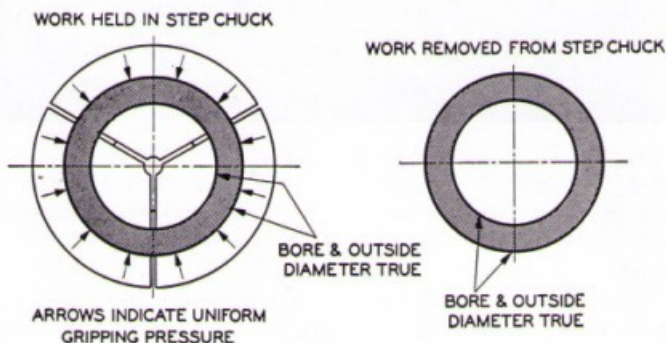

the gripping pressure is uniformly distributed over the entire circumference of the work. The large gripping area prevents distortion and eliminates marking of the work.

**WHEN USING JAW CHUCKS:** Studied consideration of the gripping pressure applied on the work by a jaw chuck clearly shows the disadvantage of using jaw chucks for precision work.

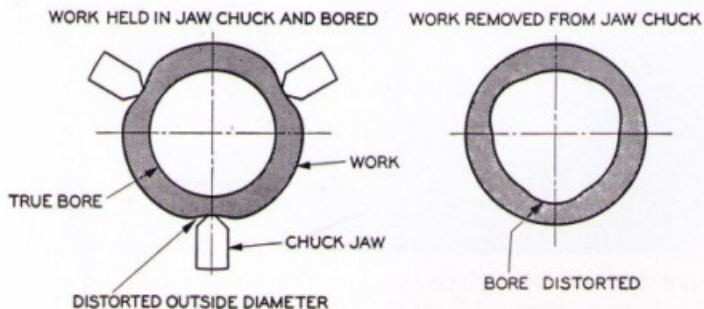

Note how the localized gripping pressure of the jaws distorts the work. The small area of the gripping surface of the chuck jaws will also mark the surface of the work.

# INSTRUCTIONS FOR "STEP

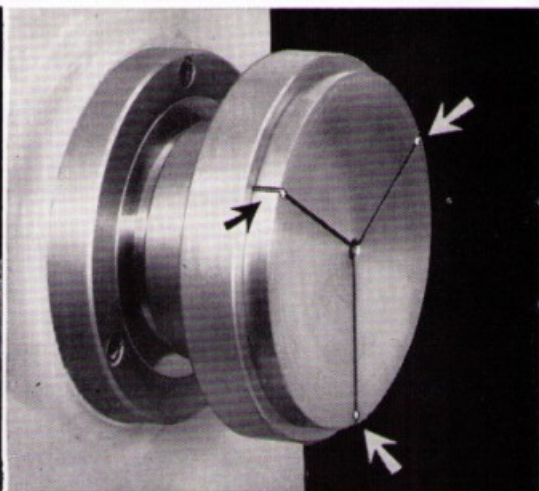
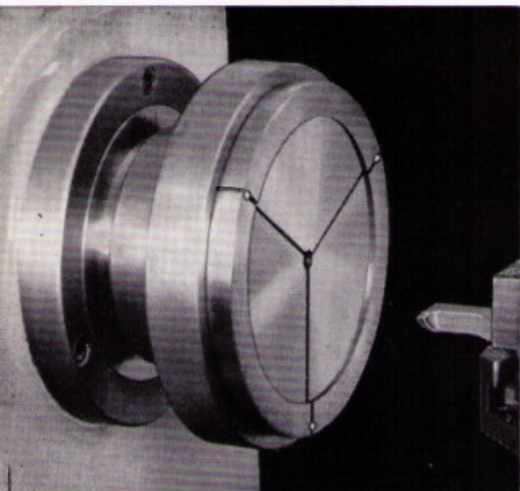

1. Clean nose of spindle. Apply a few drops of oil to outside of spindle. Clean spindle bore of step chuck closer. Apply closer to headstock spindle and tighten closer with spanner wrench. (Use Williams or Armstrong spanner wrench No. 460).  
**Do not use punch and hammer.**

2. Clean inside of headstock spindle and outside of step chuck. Apply step chuck to spindle and collet closer. Be sure pins are in place. Adjust collet closer and close step chuck.

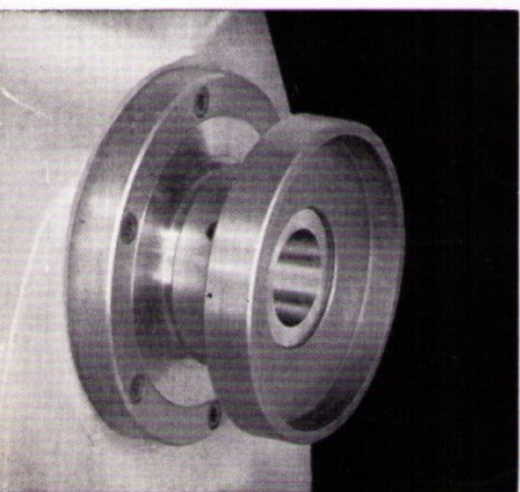

5. Finish bore to exact size of part to be held. Face bottom of bore in step chuck. If section of part to be held has a sharp corner, undercut corner of bore in step chuck.

6. Clean bore of step chuck and use part as gage. Part should fit into step chuck like a good precision plug gage fit.



# PING OUT" STEP CHUCKS

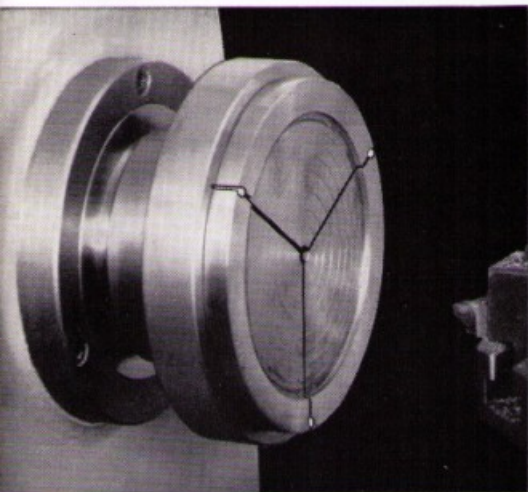

3. With sharp carbide boring tool, rough bore step chuck to approximate size. The step chuck may be rapidly bored by using the plunge cut stepping method.

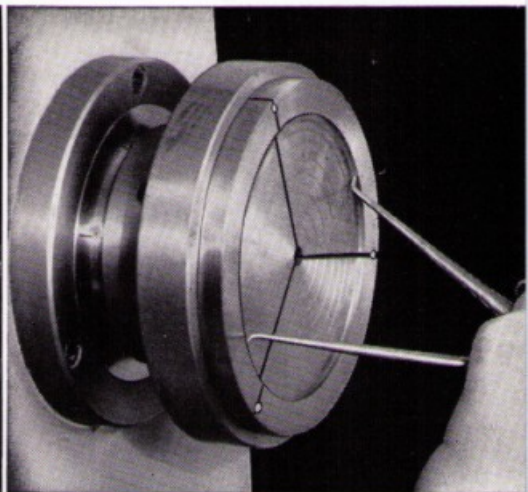

4. "Stepping out" of a step chuck requires care that bore is not oversize. When "roughing-out" use calipers, set slightly smaller than required size, to check bore diameter.



7. Remove step chuck. Clean step chuck closer and spindle. Wipe a few drops of oil on angle of step chuck closer and inside spindle. Perform this operation occasionally during a production run to assure accuracy of step chucks.

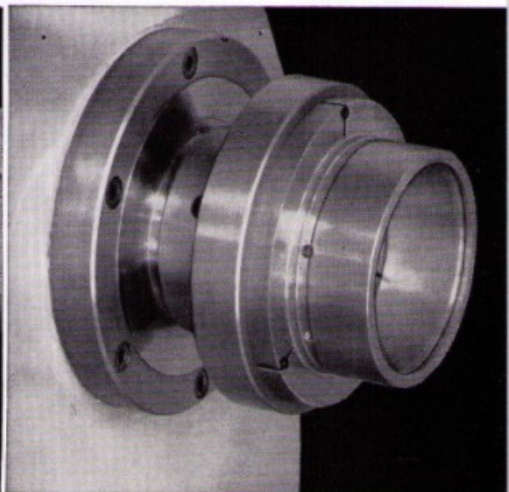

8. Remove pins from slots of step chuck. Clean each slot of step chuck of all chips and apply step chuck to machine spindle. Adjust collet closer for tension and you are ready to run production.

# CARRIAGE TOOLING

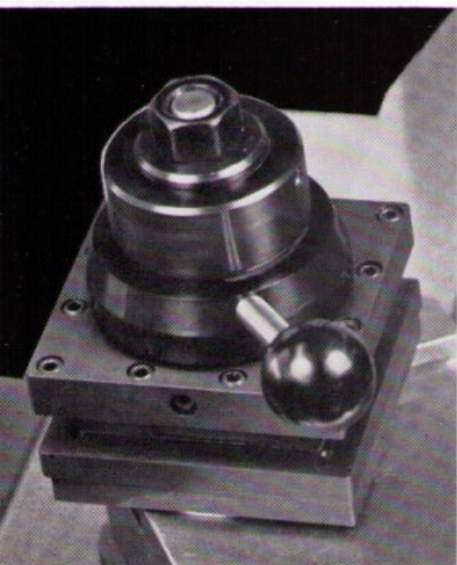

## AUTOMATIC SQUARE INDEXING TURRET

The square turret is applied directly to the tool post T-slot of the compound slide. The turret takes standard  $\frac{3}{8}$ " square tool bits. By a simple movement of the ball-handled lever, the turret is automatically unlocked, indexed to the next tool position and automatically relocked, ready for the next machining operation. Accurate indexing is accomplished through a hardened and precision ground tapered index pin.

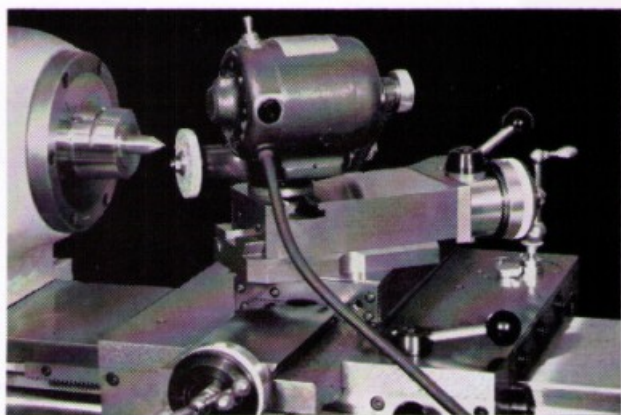

## MOTOR GRINDER

The motor grinder unit mounts directly to the compound slide T-slot. It can be used for both external and internal grinding. Motor operates on 110 volt, single phase current. When grinding, keep as much of the bed, carriage and apron as possible covered with oil-soaked cloths to prevent abrasive material from causing injury to machine.



# CARRIAGE TOOLING

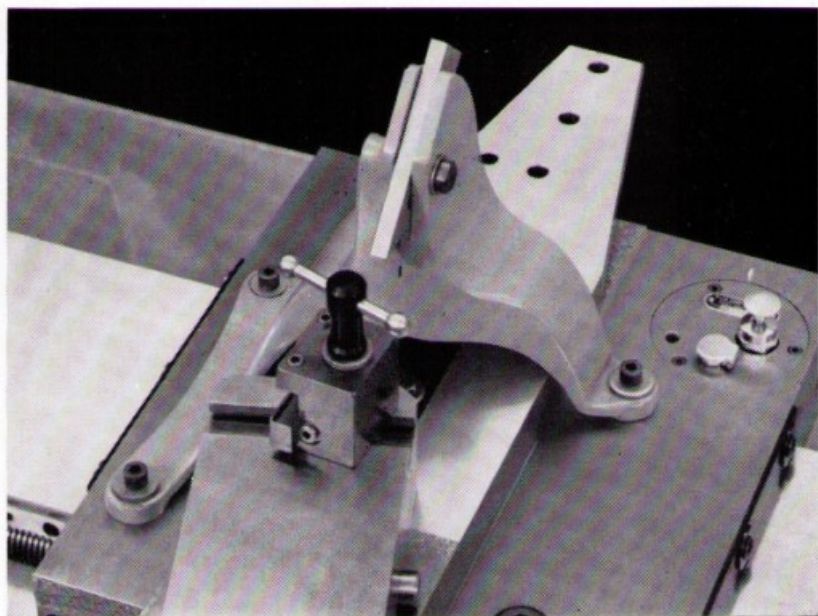

## FOLLOWER REST

The follower rest is mounted directly to the carriage and is used to support work which, because of its small diameter in relation to length, may spring away from the cutting tool.

To apply the follower rest to the carriage remove three plug screws indicated as "G", Figure 13, Page 24. Be sure to replace the screws after using follower rest as they keep holes free of chips and will make it easier to mount follower rest the next time it is required.

The jaw of the follower rest is adjustable to suit the work diameter.

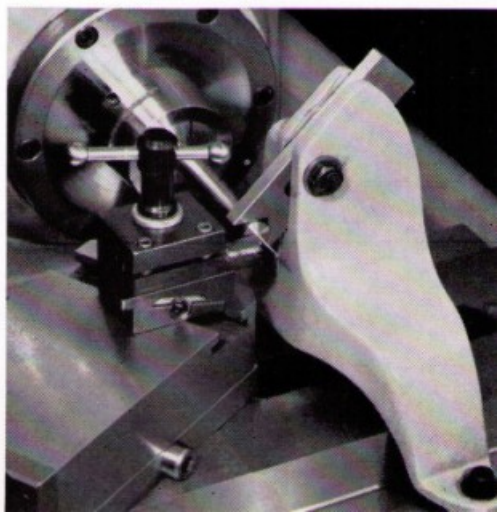

# CARRIAGE and BED TOOLING

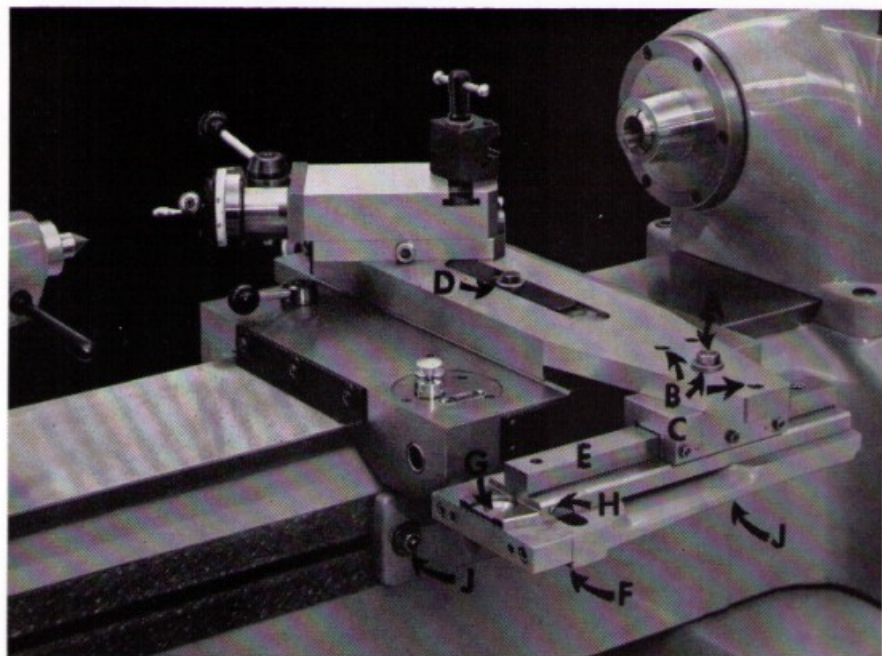

## TAPER TURNING ATTACHMENT

The turning or boring of precision tapers is readily accomplished on the Hardinge HLV-H Lathe by the use of a taper turning attachment. The Hardinge taper turning attachment is based on the sine bar principle — swiveling the guide bar from one end. See Page 3 for a typical taper turning setup.

The taper turning attachment mounts directly on the back of the lathe bed and is adjustable along the bed to suit the work.

In operation, the taper turning attachment is moved into position to suit the work by loosening two nuts "J". Clean attachment of all chips and foreign matter. Then place the cross slide in position so that bolt "A", shown in illustration above, can be placed through any one of the three holes "B" in the cross slide to engage shoe "C". With the cutting tool in position and taper attachment secured to cross slide, release 9/16" hexagon cap screw "D" two turns — **DO NOT REMOVE CAP SCREW**. All adjustments of taper attachment are made with 9/16" wrench.



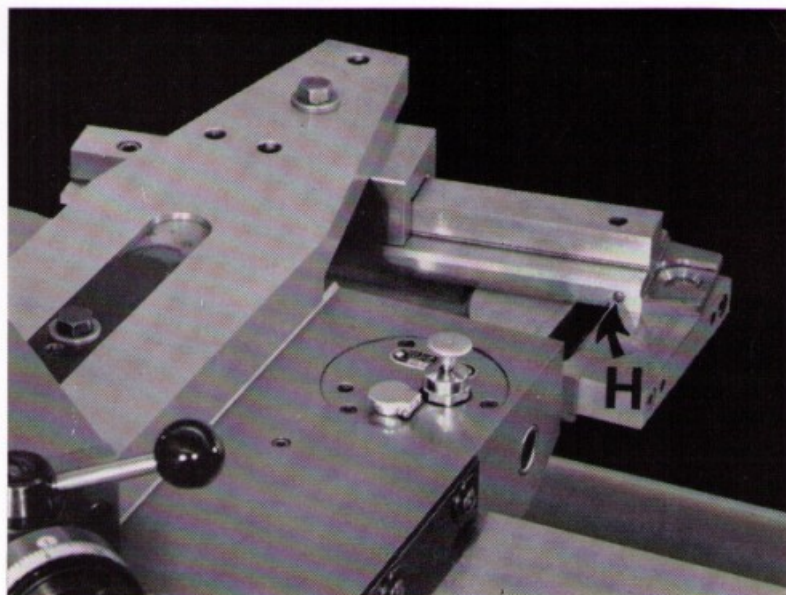

## TAPER TURNING ATTACHMENT — Continued

To set guide bar "E" to the desired angle, loosen cap screw "F". Cap screw "F" is located on the under side of the taper attachment body. Swing guide bar "E" to desired angle or taper per foot according to graduation viewed through zero plate "G".

Lock guide bar in place with cap screw "F" and tighten cap screw "A". Make a test cut. It may be necessary to move guide bar a very small amount to obtain the exact taper for a blued fit to the taper gage. Loosen cap screw "F" and "A" a very small amount and tap guide bar lightly to move it into position to give exact taper. Then lock cap screws "F" and "A" **tight**. When tapping guide bar "E" strike it on hardened pins "H" protruding from the surface at the sides of the guide bar.

Lubricate guide bar with spindle oil.

**IMPORTANT:** When turning or boring a taper be sure the cutting tool is exactly on center; otherwise a true taper will not be produced.

When the taper attachment is not in use keep at tailstock end of the bed.

# CARRIAGE and BED TOOLING

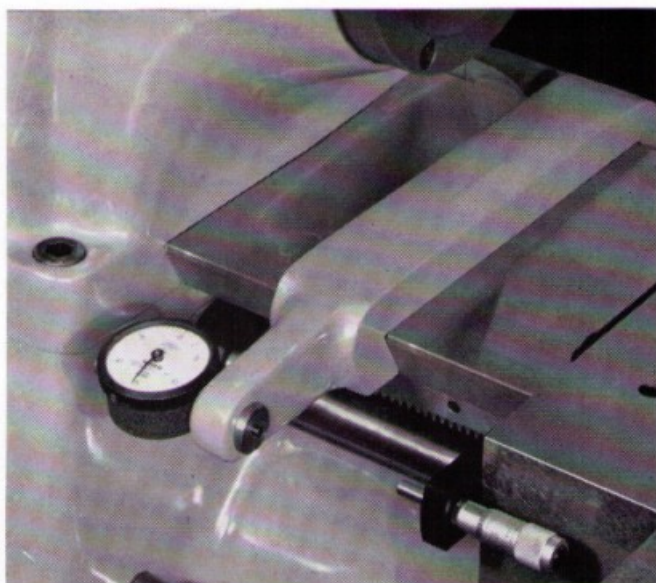

## MICROMETER CARRIAGE STOP WITH DIAL INDICATOR

The micrometer carriage stop is a useful accessory when producing parts having exact shoulder lengths.

All Hardinge HLV-H Lathes are now equipped with a tapped hole in the carriage for fastening the micrometer to the carriage. The bracket carrying the indicator mounts directly to the hardened and ground dovetail bed ways.

The indicator reads in .0005" increments. The micrometer reads in .001". Measurements are made with the micrometer. Carriage is moved until the indicator reads zero.



# BED TOOLING

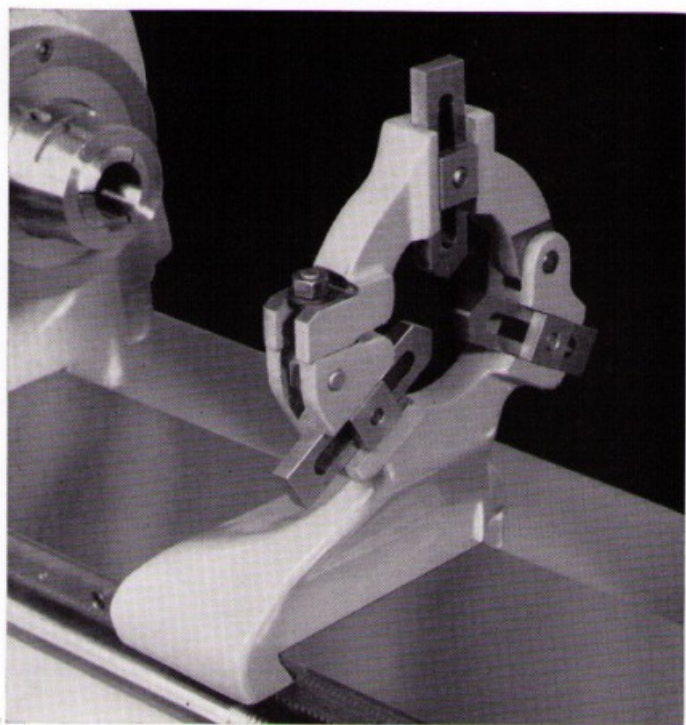

## STEADY REST

Long cylindrical work held between centers requires a steady rest to prevent such work from springing away from a cutting tool. A steady rest is also used when there are machining operations to be performed on the end of work which prohibits the use of the tailstock center. The three jaws are adjustable and have an accurate fit in the machined guides of the body. The top section is hinged to provide ease in loading shoulder work without disturbing the setting of the jaws. The steady rest has a maximum capacity of 3".

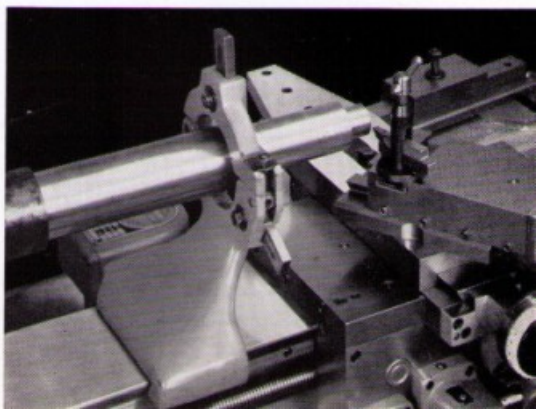

# BED TOOLING

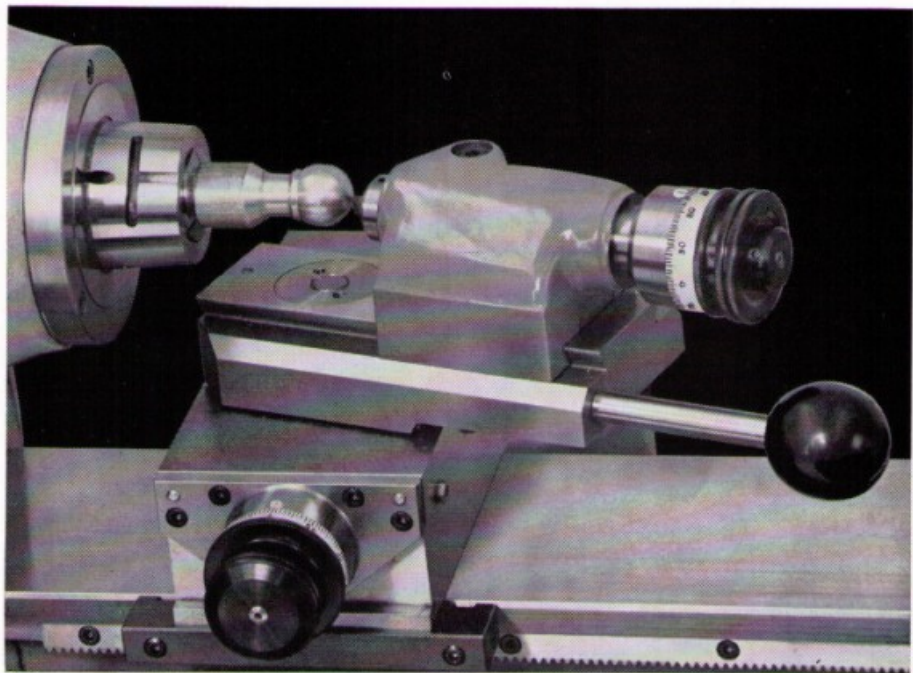

## RADIUS TURNING ATTACHMENT

This attachment fastens directly to the dovetail bed, as shown above, and is used for precision turning concave or convex surfaces up to 1-1/2" radius. Useful for turning punches, dies, ball shaped valve seats and special spherical cutting tools.

The swivel slide is mounted on precision preloaded ball bearings for accuracy and rigidity. The swivel slide moves through 360°. Hardened feed screws are mounted on preloaded ball bearings and have adjustable dials graduated in thousandths of an inch.

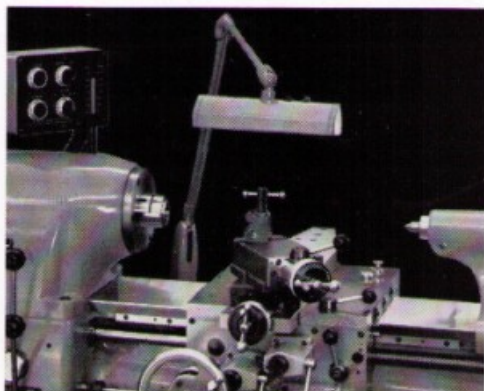

## LAMP

This fluorescent lamp is available for use with the Hardinge HLV-H Lathe. The lamp fastens to the back of the lathe bed and operates from the regular 110 volt light line.



# TAILSTOCK TOOLING\*

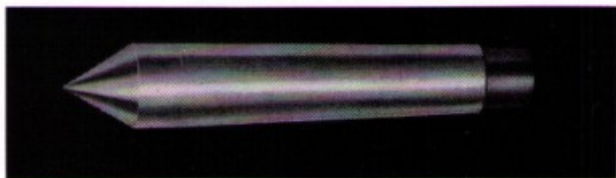

**MALE CENTER**

This male center has a  $11/16''$  head diameter and is furnished with all Hardinge tailstocks. All centers are hardened and ground.

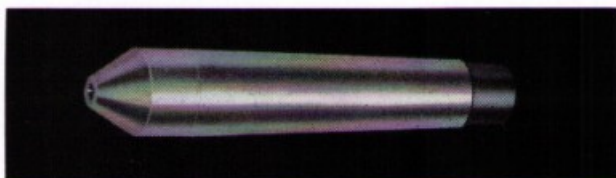

**FEMALE CENTER**

A female center is used for work that cannot have the usual center hole. The  $11/16''$  head has a  $60^\circ$  conical hole  $1/8''$  in diameter at the large end.

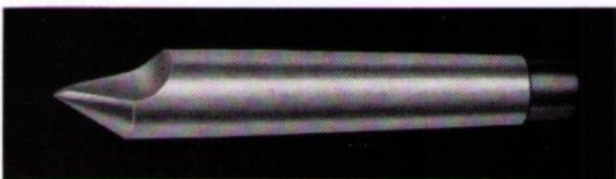

**HALF CENTER**

A half center is used if tool clearance is desired when turning the full length of a part supported by the tailstock. The head diameter is  $11/16''$ .

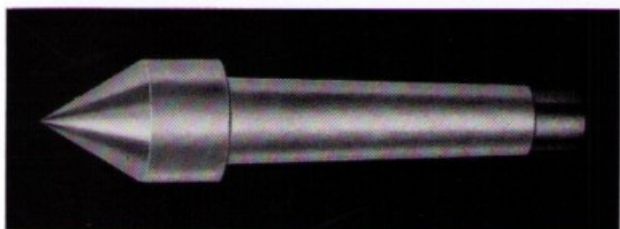

**LARGE CENTER**

This center has a head diameter of  $1''$ . It is indispensable for supporting tubing or recessed work too large for the standard male center.

\* When ordering, specify No. 2 Morse Taper Shank.

# TAILSTOCK TOOLING\*



## V CENTER

The swivel V center is constructed so the V block rotates on the shank.

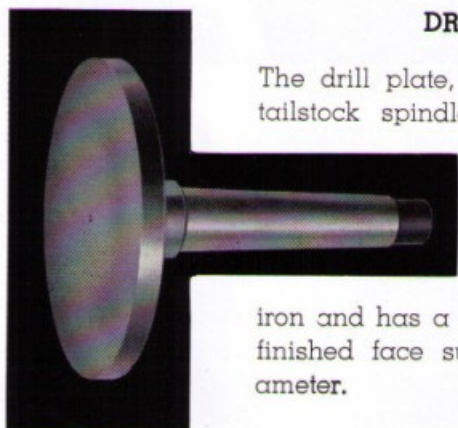

## DRILL PLATE

The drill plate, when in place in the tailstock spindle, is used to support work at right angles to the machine spindle center line. The plate is made of close-grained cast iron and has a steel taper shank. The finished face surface is 3-1/2" in diameter.

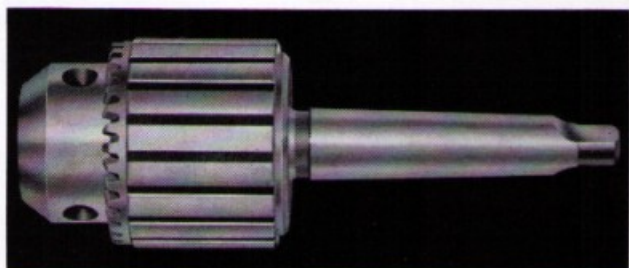

## DRILL CHUCK

We recommend the improved type drill chucks with our tailstocks. We carry 0-1/8", 0-3/8" and 0-1/2" sizes in stock mounted ready for use.

\* When ordering, specify No. 2 Morse Taper Shank.



# TOOLING

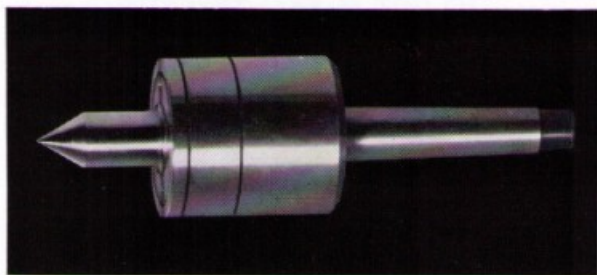

## ANTI-FRICTION CENTER FOR TAILSTOCK

This heavy duty anti-friction center has a No. 2 Morse Taper shank for direct application to the tailstock spindle. Work can be done between centers at high speed when the anti-friction center is used.



## ADJUSTABLE HEIGHT CHAIR

The seat of the chair has infinite adjustment to suit the operator and can be adjusted without the use of tools. Unlocking and locking, after adjustment of the chair to correct height position, is automatic through the use of a special ball bearing device. The back rest is also adjustable.

# TOOLING

## TO CUT METRIC THREADS

By the application of a metric attachment to the gear box, in place of the English bracket for the outside change gears, metric threads can be cut. For threading, follow the same procedure as when setting up English threads as described on Page 33.

Gears supplied for the English outside gear can also be used in the gear setup for metric threads.

When metric attachment is supplied with machine, a large gear cover is shipped as standard equipment. When the metric attachment is supplied later, the large cover is supplied to replace the standard cover.

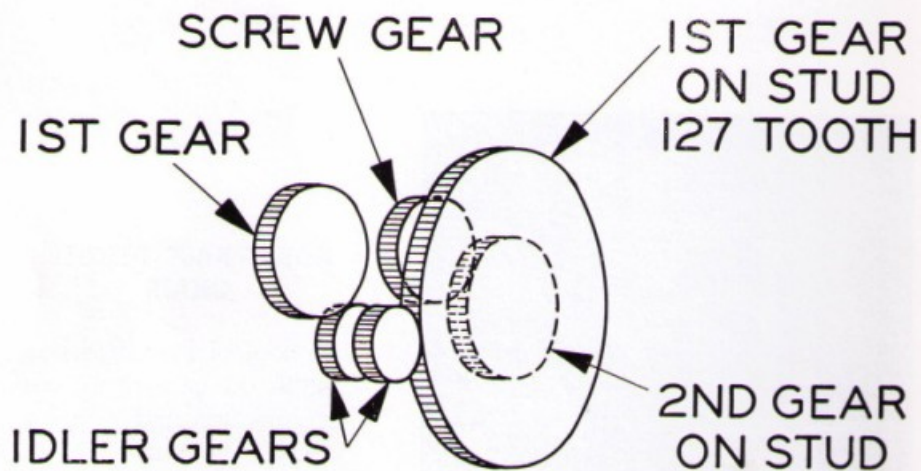

See Gear Chart on Opposite Page



# TOOLING

<u>PITCH IN MM</u>	<u>KNOB</u>	<u>FIRST GEAR</u>	<u>SECOND GEAR ON STUD</u>	<u>IDLER GEAR</u>	<u>SCREW GEAR</u>
.1	3	25	40	50	50
.2	2	25	40	50	50
.25	2	25	50	40	50
.30	2	25	60	40	50
.35	3	50	70	30	50
.40	1	25	40	50	50
.45	3	50	54	30	30
.50*	3	50	60	30	30
.55	1	25	55	40	50
.60	1	25	60	40	50
.65	2	50	65	30	50
.70	2	50	70	30	50
.75	3	50	66	30	22
.80	2	50	56	30	35
.85	2	50	68	50	40
.90	2	50	54	30	30
.95	2	50	76	30	40
1.00*	2	50	60	30	30
1.10	1	50	55	30	50
1.20	1	50	60	30	50
1.25	2	50	60	30	24
1.30	1	50	65	30	50
1.40	1	50	70	30	50
1.50	2	50	66	30	22
1.60	1	50	56	30	35
1.70	1	50	68	30	40
1.75	2	50	77	30	22
1.80	1	50	54	30	30
1.90	1	50	76	30	40
2.00*	1	50	60	30	30
2.25	1	60	60	30	32
2.50	1	50	60	30	24
2.75	1	50	66	30	24
3.00	1	50	66	55	22

\* Pitches that can be cut with standard gears supplied with machine and metric attachment.

# TOOLING

## COOLANT FACILITIES

All Hardinge HLV-H Lathes are provided with the coolant facilities required for high speed work. The coolant pump is conveniently located at the rear of the machine and above the sump level, thus eliminating troublesome check valves. The centrifugal type pump needs no priming and is controlled by a switch conveniently located in the control box on the headstock of the machine. Refer to page 11 for coolant pump switch instructions.

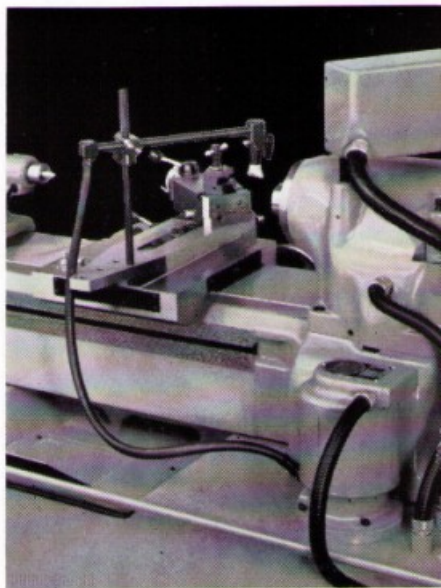

Clean sump regularly, depending upon type of material being run. When machining cast iron or other powdery material without coolant, close sump screen cover to prevent powdery material from mixing with coolant.

## **OIL BASE CUTTING FLUIDS ARE RECOMMENDED FOR MAXIMUM MACHINE LIFE.**

To clean sump remove the four screws, one in each corner of the screen cover for sump. Lift screen cover from sump. Clean sump. Rinse out and drain sump by removing pipe plug from bottom of sump. This plug is easily accessible from the back of the machine.



# TOOLING

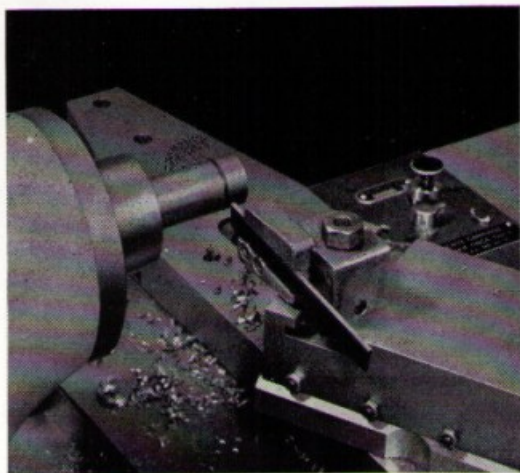

## CUT-OFF TOOL HOLDER

This patented cut-off tool holder fits directly to the compound slide. The blade and serrated blade holder are adjustable. The holder is furnished with a wrench for locking the blade in place — less blade. Blades are available in 1/16", 3/32" or 1/8" sizes. When ordering, specify desired blade thickness.

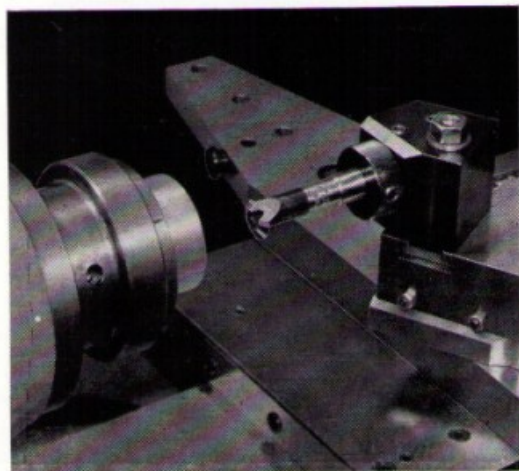

## BORING TOOL HOLDER

This boring tool holder is available for use with the Hardinge HLV-H Lathe. The holder mounts directly to the T-slot of the compound slide and adapts standard 5/8" diameter boring bars. An eccentric bushing permits height adjustment of the tool. Holder is supplied less boring tool.

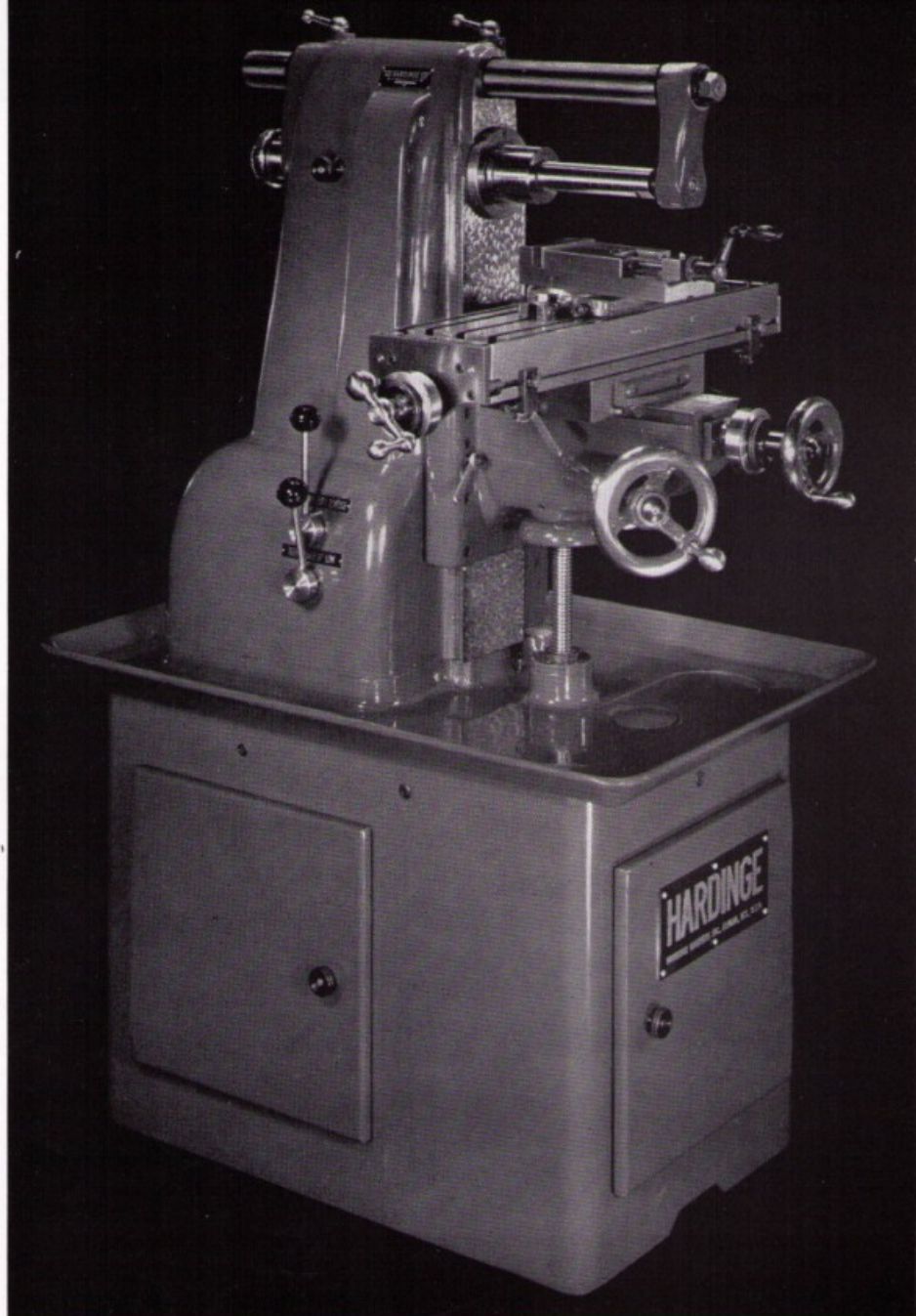

### **HARDINGE HIGH SPEED PRECISION MILLING MACHINE**

Hardinge HLV-H Lathe and the Hardinge Milling Machine are companion units with interchangeable attachments, abundance of power, speed and accuracy.

The Hardinge Milling Machine is available in both plain and universal models. Descriptive Bulletin TM-UM will be furnished upon request.