

INSTRUCTIONS and PARTS

CLAUSING

DIVISION, ATLAS PRESS COMPANY
KALAMAZOO, MICHIGAN 49001

NO. 7214 TELESCOPIC TAPER ATTACHMENT

for

6900 SERIES CLAUSING 14" LATHES

JULY, 1967

FILE NO. 7214-2

1.
2.
3.
4.

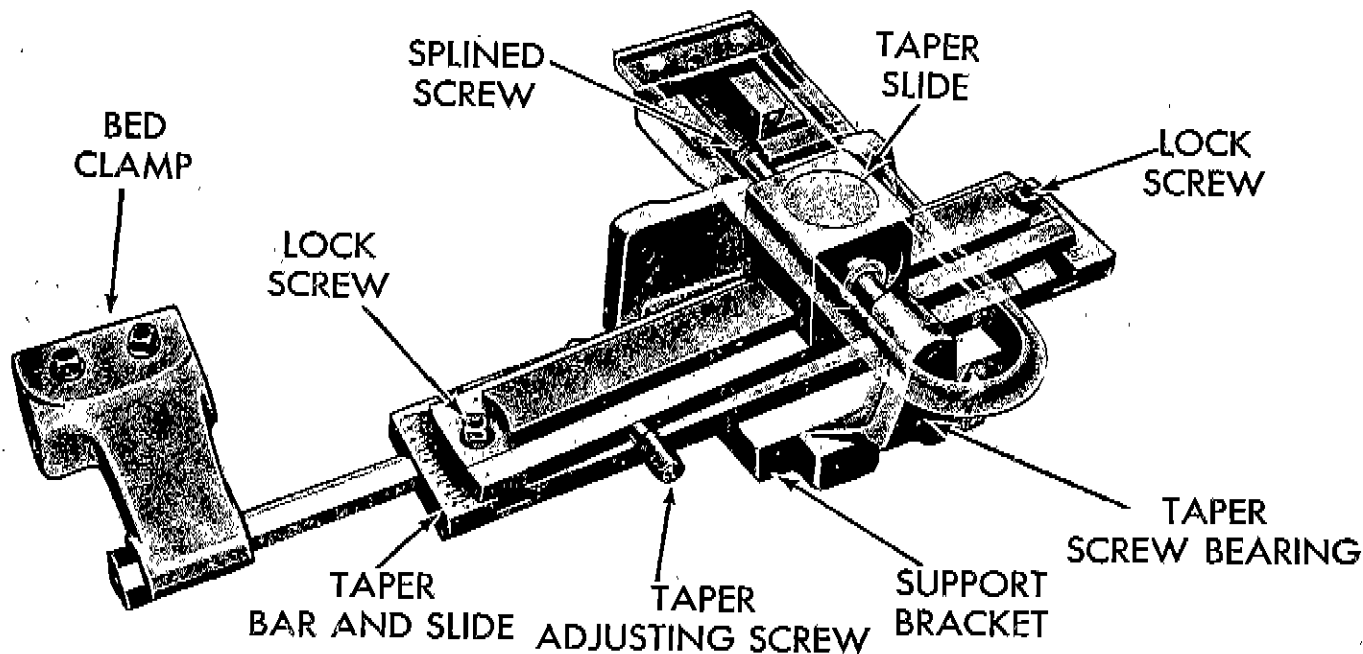

INSTALLATION

1. Remove taper attachment and bag of mounting bolts from box.
2. Use a grease solvent to remove rust-proof coating from unpainted surfaces of taper attachment.

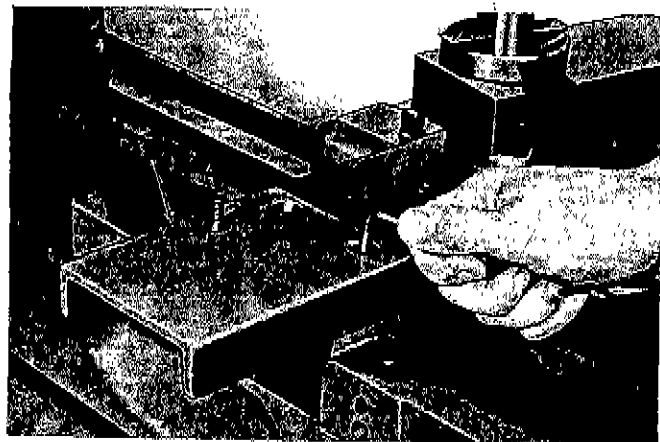

Figure 1

3. Remove chip guard (A, fig. 1) from cross slide.

4. Remove the two soc. cap screws from cross slide screw bracket, and pull out assembly.

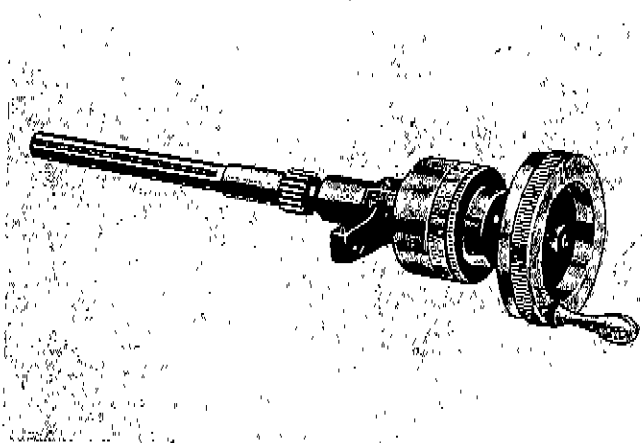

Figure 2

5. Take the cross slide screw assembly apart. Re-assemble the parts on cross slide screw furnished with taper attachment -- refer to figure 2.
6. Slide taper bar off support bracket.

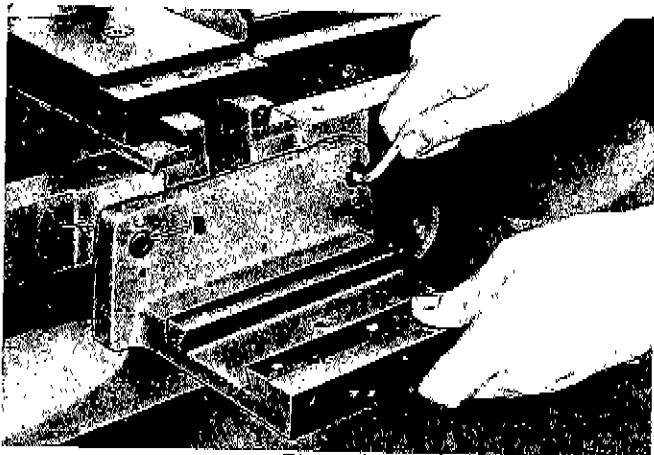

Figure 3

7. Mount support bracket (A, fig. 3) to rear of carriage with screws (B) furnished. Do not tighten the screws.

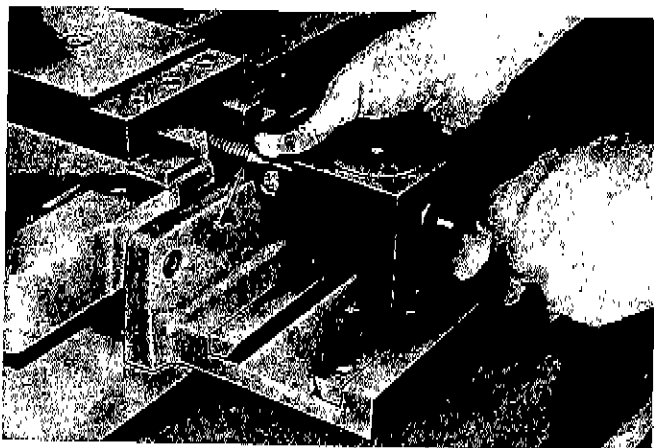

Figure 4

8. Carefully turn splined screw (A, fig. 4) counter-clockwise about 2" on cross feed nut.

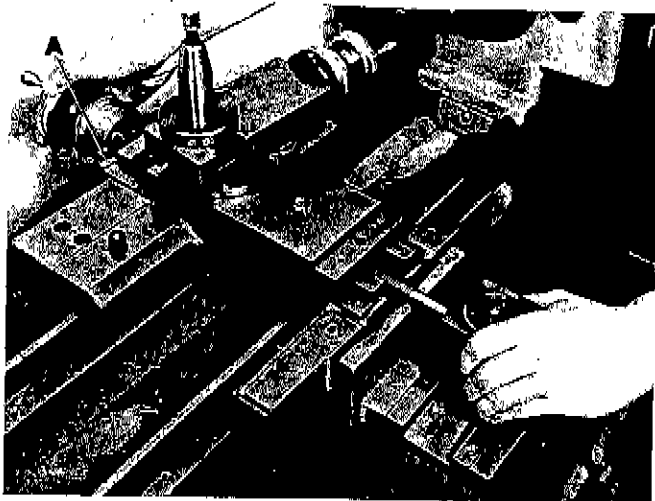

Figure 5

9. Slide the new cross slide screw assembly (A, fig. 5) into carriage and turn clockwise so the splines mesh with those in the splined screw. When the splines mesh, push the assembly all the way in and mount bracket to carriage with two soc. cap screws.

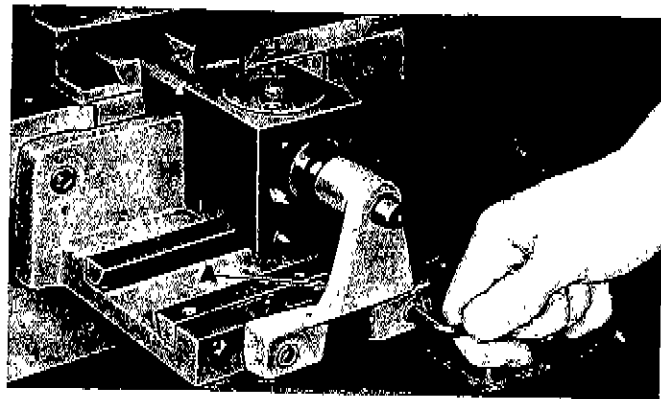

Figure 6

10. Slide taper screw bearing support (A, fig. 6) onto splined screw, and bolt loosely to support bracket.

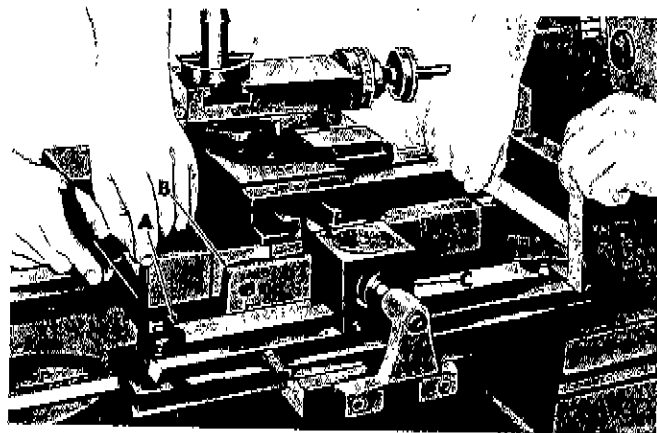

Figure 7

11. Slide taper bar (A, fig. 7) on support bracket (B) and into taper slide (C).
12. Check taper bar to make sure it is parallel with top of bed ways -- place a straight edge across bed ways, and measure the distance between straight edge and top surface of bar. Reading should be identical at both ends. If not, adjust the support bracket (B) until readings are identical; then tighten screws securely.

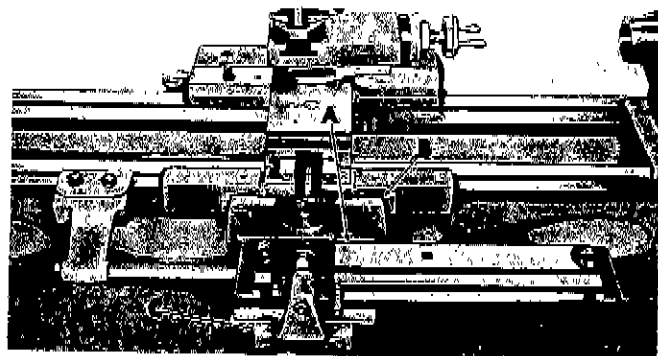

Figure 8

13. Make sure spline screw is properly aligned. Slide taper bar (A) to extreme left and extreme right. IF SCREW BINDS IN EITHER POSITION, RE-ADJUST SUPPORT BRACKET (B). Tighten taper screw bearing support (C).

- Remove the taper bar and slide, Drill two 1/4" holes 1-1/4" deep in support bracket (B, fig. 9), and in bearing support (A). Install pins (furnished) flush with surface.

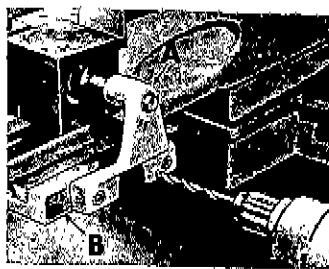

Figure 9

- Replace the taper bar and slide, and rest bed clamp on top of bed way.

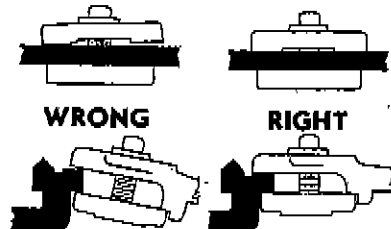

Figure 10

IMPORTANT—before clamping bracket to the bed, make sure bracket bears on bed evenly (refer to figure 10). If it doesn't fit evenly, check taper bar alignment to make sure it is parallel with the lathe bed -- refer to step 12. If clamp still doesn't bear evenly on bed, file clamp until it fits properly.

- Tighten feed nut lock, and mount chip guard, furnished with taper attachment, to lathe cross slide.

OPERATION

- Mount work in the lathe—whenever possible the cut should be made as shown in figure 11 for boring taper and figure 12 for turning taper.
- Set point of tool bit on exact center line.
- Lathe cross slide and taper slide should move freely, but with no up or down play. Adjust the tension with the gib screws in the cross slide and support bracket.
- Position taper attachment so it is about in the center of the work. Lock clamp bracket to lathe bed.
- Move the carriage by hand to make sure there is sufficient travel to complete the taper cut. If there isn't, adjust the compound rest, move the carriage or the taper attachment to a different position.
- Set the taper bar to taper desired — graduations on left end of bar are marked in degrees (graduations indicate included angle) — the right end in inches per foot.

FINDING TAPER PER FOOT

Taper per foot is the difference between the diameters of two ends of a tapered piece of work, expressed in inches per foot of length. Taper Per Foot is determined as follows:

Assume a piece of stock has a diameter of 3 1/4" at one end, 2 1/2" at the other, and is 8" long.

$$\text{Taper per foot (in inches)} = \frac{12 (3\frac{1}{4} - 2\frac{1}{2})}{8}$$

$$\text{Taper per foot (in inches)} = \frac{12 \times .750}{8} = 1.125''$$

Set the taper slide on the 1-1/8 graduation mark to right or left of zero, depending upon which way the taper is cut.

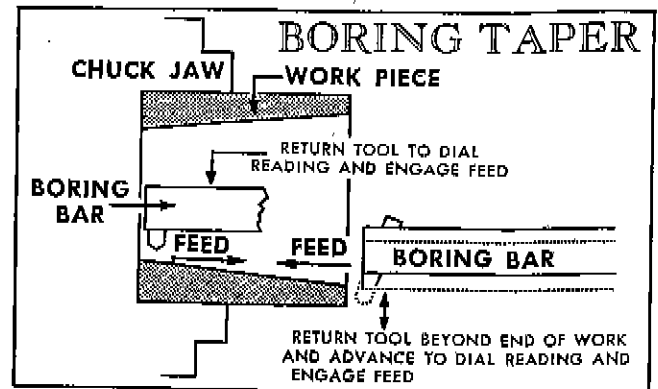

FIGURE 11

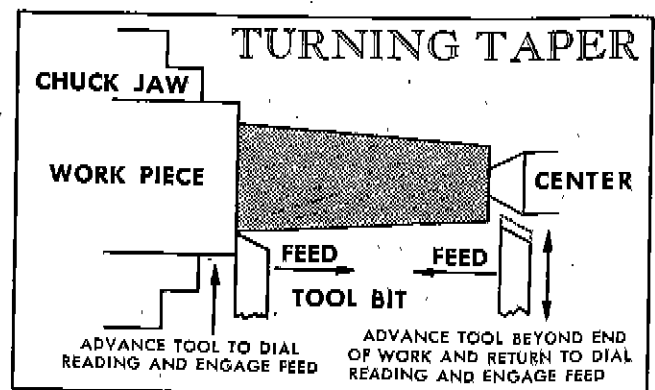

FIGURE 12

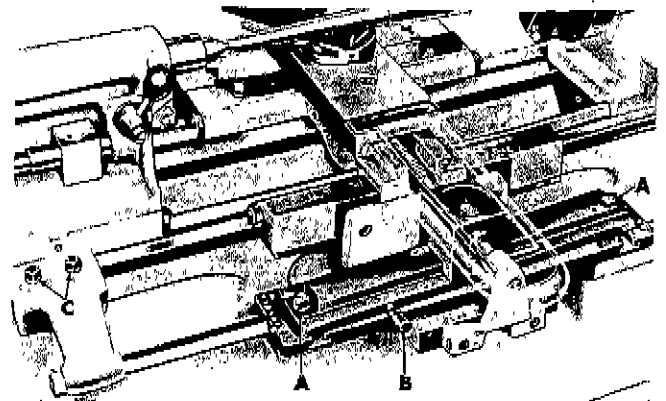
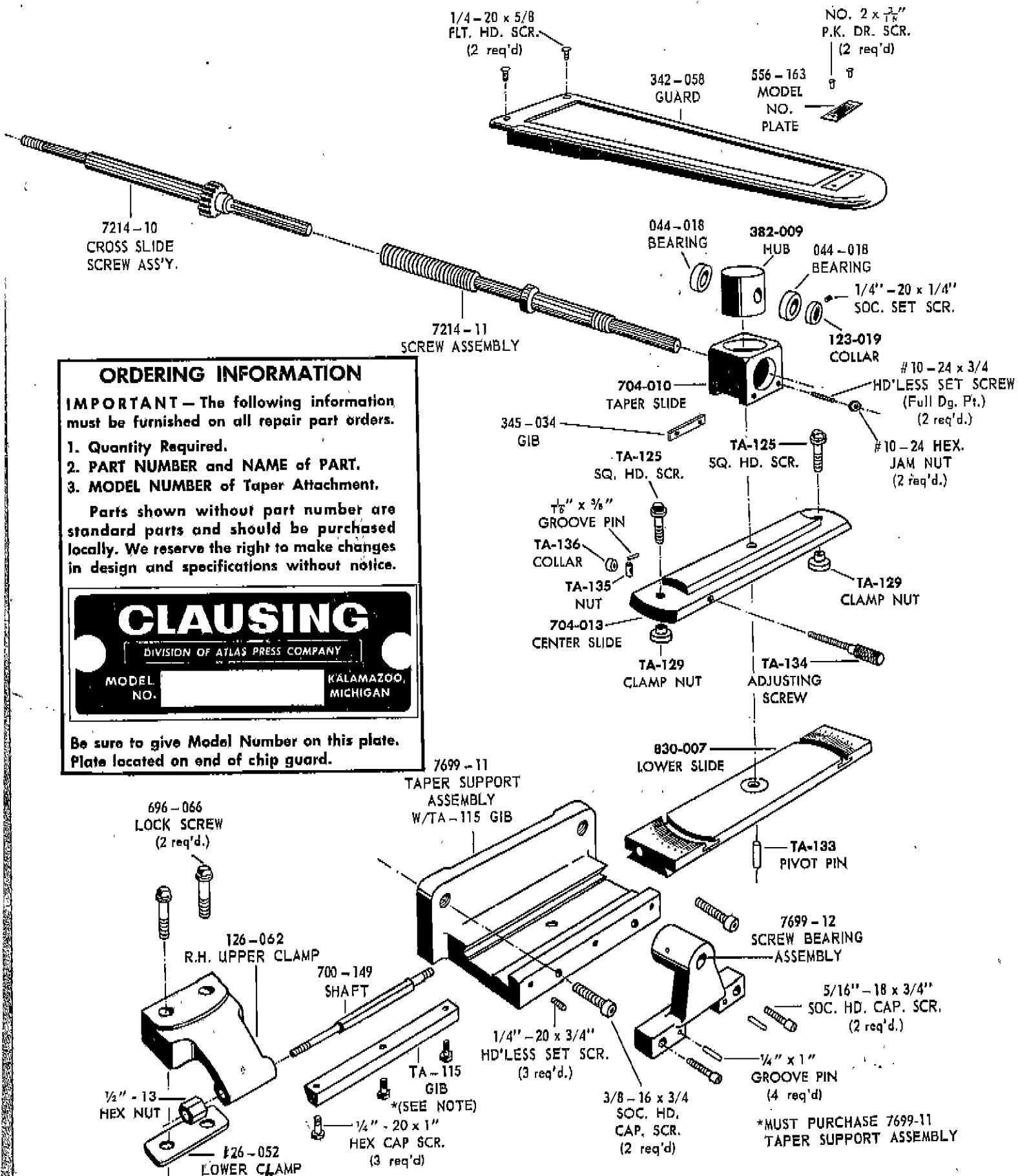

FIGURE 13

- To set the attachment for taper desired —
 - Loosen the two lock screws (A, fig. 13) on each end of taper bar.
 - Turn taper adjusting screw (B) to taper desired.
 - Tighten the two taper bar lock screws (A).
 - Be sure clamp bracket (C) is locked to lathe bed.
- Engage feed with tool approximately 1" away from beginning of cut to be sure backlash is removed before tool commences to cut.

Caution: When taper attachment is not in use, loosen clamp (C) so it will slide freely along lathe bed with the movement of the carriage.

NO. 7214 TAPER ATTACHMENT PARTS LIST



ORDERING INFORMATION

IMPORTANT — The following information must be furnished on all repair part orders.

1. Quantity Required.
2. PART NUMBER and NAME of PART.
3. MODEL NUMBER of Taper Attachment.

Parts shown without part number are standard parts and should be purchased locally. We reserve the right to make changes in design and specifications without notice.

CLAUSING

DIVISION OF ATLAS PRESS COMPANY

MODEL NO.

KALAMAZOO, MICHIGAN

Be sure to give Model Number on this plate.
Plate located on end of chip guard.

*MUST PURCHASE 7699-11
TAPER SUPPORT ASSEMBLY